

© ELECTROLUX HOME PRODUCTS
Customer Care - EMEA
Training and Operations Support
Technical Support

Publication
number

599 74 32-54

EN

Edition: 08/2015 - Rev. 01

**Condensation
tumble dryer
with heat pump**

New Collection

SERIES 6 / 7 / 8 / 9

Disassembly instructions

INDEX

1	Safety and installation	5
1.1	Safety measures.....	5
1.2	Installation	6
2	Technical characteristics	7
3	Operating characteristics and construction	8
3.1	Principle of the heat pump.....	8
3.2	Low consumption mode	9
3.3	Manufacturing characteristics.....	10
3.3.1	Drum	11
3.3.2	Air seal and drum rollers.....	11
3.3.3	Water circuit.....	12
3.3.4	Drum rotation principle.....	12
4	Electric components	13
4.1	Control board.....	13
4.2	Main electronic circuit board.....	14
4.2.1	Main circuit board functions	15
4.3	Inverter motor control board	16
4.4	Conductivity sensor	17
4.5	Tank filling pump	17
4.6	Level sensor	17
4.7	NTC probe.....	18
4.8	Drum light	18
4.9	Compressor	19
4.10	Thermal cut-out	19
4.11	Compressor motor capacitor	19
4.12	Compressor cooling fan	20
4.13	Door micro-switch.....	20
4.14	Motor	21
4.14.1	Asynchronous three-phase or Inverter motor technical details	21
5	Selector dial positions in diagnostics.....	23
6	Access to components	27
6.1	Upper fluff filter cleaning.....	27
6.2	Capacitor filter cleaning.....	27
6.3	Clean condensation water filter	28
6.4	Worktop	28
6.5	Sides.....	29
6.6	Main electronic circuit board.....	30
6.7	Panel de control.....	30
6.7.1	Control board	31
6.7.2	Programme selector know series 6	31
6.7.3	Programme selector know series 7-8-9.....	31
6.7.4	Buttons spring and LED light diffuser	32
6.7.5	Buttons.....	32
6.8	Door	33
6.8.1	Plastic door handle, latch and hinge.....	33
6.8.2	Plastic door micro switch lever	34
6.8.3	Glass door handle, latch and hinge	35
6.8.4	Glass door micro-switch lever.....	35
6.9	Level sensor and condensation water pump.....	36
6.9.1	Level sensor.....	36

6.9.2	Condensation water pump.....	37
6.10	Inverter board and three-phase asynchronous motor.....	38
6.11	Rotating compressor running capacitor	39
6.12	Temperature probe.....	40
6.13	Motor protector	40
6.14	Rear panel.....	41
6.15	Rear air seal	42
6.16	Anti-entanglement cone	42
6.17	Frontal piece.....	43
6.18	Drum light	43
6.19	Door micro-switch.....	44
6.20	Base board	44
6.21	Compressor cooling fan	45
6.22	Front air conduit.....	46
6.23	Front air seal.....	46
6.24	Heat exchanger compartment door.....	47
6.24.1	Heat exchanger compartment door seal	47
7	Alarms	48
7.1	Alarm display during normal operation.....	48
7.2	Reading the alarms	48
7.3	Cancelling the last alarm memorised	49
7.4	Notes about specific alarm codes	49
7.5	ENV06 TUMBLE DRYERS ALARMS TABLE SUMMARY	50
8	Troubleshooting.....	57
8.1	The diagnostics programme cannot be accessed.....	57
8.2	The LEDs do not light up after the buttons are pressed	58
8.3	The drying cycle is long and the washing is still humid.....	59
8.4	Checking the heat pump performance	60
8.4.1	Models without auxiliary capacitor HP A-50%	60
8.4.2	Models with auxiliary capacitor HP 2C	61
8.5	Servicing the heat pump circuit	62
8.5.1	Replace compressor.....	62
8.5.2	Filling.....	63
9	Door reversibility.....	64
10	Revisions	66

1 Safety and installation

1.1 Safety measures



- Before starting work on a piece of equipment, check that the earth in the lodgings is working properly by using an appropriate tool and follow the instructions described / illustrated on the Electrolux Learning Gateway portal
- <http://electrolux.edvantage.net>
- When the work is finished check that the equipment's safety conditions have been reinstated, as though it were straight off the assembly line.
- In the event of replacing electrical parts, carefully check that all the connections have been re-connected professionally.
- In the event of handling / replacing the electronic circuit board, use the ESD (Cod. 405 50 63-95/4) kit to avoid electrostatic discharges damaging the electronic circuit board see S.B. No. 599 72 08-09.

- All the work to be performed inside the appliance requires specific skills and knowledge and may only be carried out by qualified and authorised service engineers.
- Some of the components in the mechanical part could cause injuries, so wear suitable protection and proceed with caution.

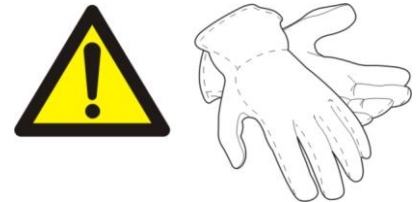

- This platform is not fitted with an ON / OFF switch. Before you access internal components, take the plug out of the socket to disconnect the power supply.
- Always empty all the water from the condensation tank before laying the appliance on its side.
- If the appliance has to be placed on its side for maintenance or another reason, lie it on its left side, to avoid the risk of any residual water falling onto the main circuit board.

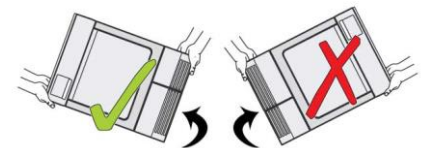

- When replacing components, please refer to the code shown in the list of spare parts relating to the appliance.

1.2 Installation

Remove the external film. If necessary use a cutter blade.

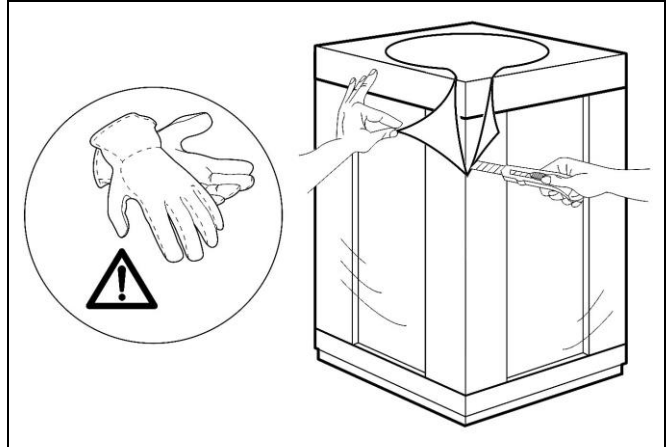

Take off the cardboard cover and remove the corner elements.

Remove the polystyrene base and set the tumble dryer in position.



The tumble dryer weighs approximately 60 kg.

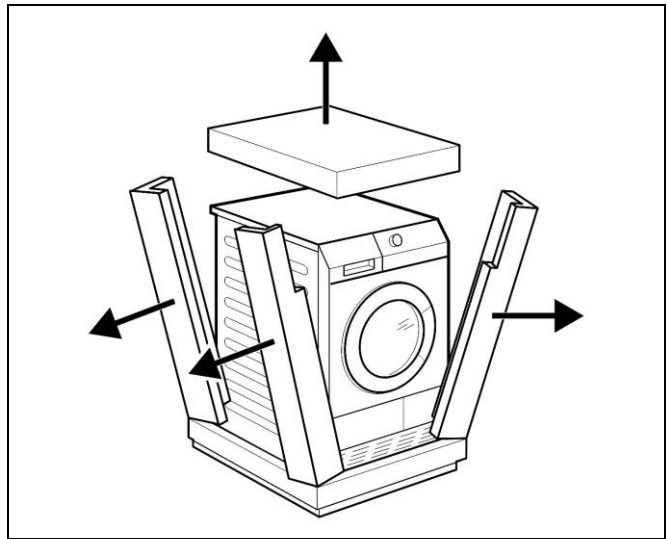

Adjust the four feet so that the appliance is installed perfectly level (using a spirit level), to allow for the correct flow of condensation water into the purpose-provided tank.



The feet must never be removed. A gap must always be left between the bottom of the tumble dryer and the floor to prevent the appliance from overheating.



2 Technical characteristics

Power supply voltage.	230 V	
Power supply frequency	50 Hz	
Energy class	A	
Maximum power absorption	1,050 W	900 W
Maximum energy consumed per 1 hour cycle	1.6 KW/h	1.85 KW/h
Drum volume	118 litres	
Foot adjustment	+1.5 cm	
Weight	approx. 40 kg	
Operating temperature	+5 °C / +35 °C	
Triple-phase motor with permanent magnets	W 222	
Motor rotating speed	2,700 rpm	
Rotating compressor	480 W 220 V	
Coolant gas	R407C	
Amount of coolant gas	570 g models without auxiliary capacitor. 650 g models with auxiliary capacitor.	
Drum speed	54 rpm	

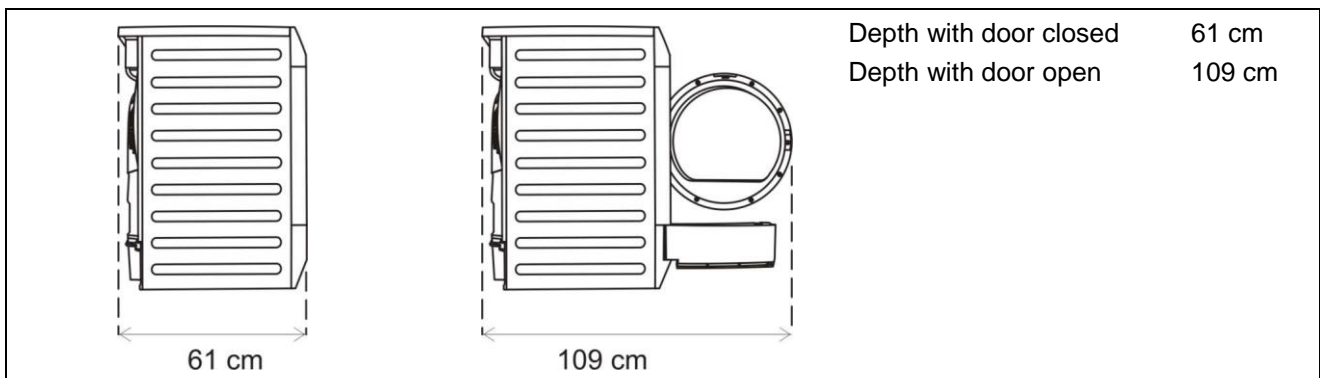
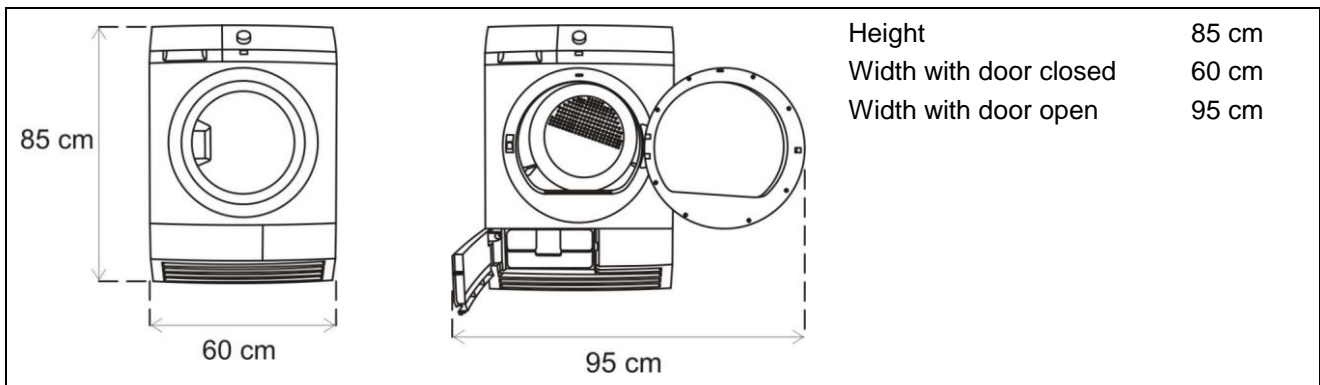

3 Operating characteristics and construction

3.1 Principle of the heat pump

Operating principle

Operating principle with auxiliary capacitor

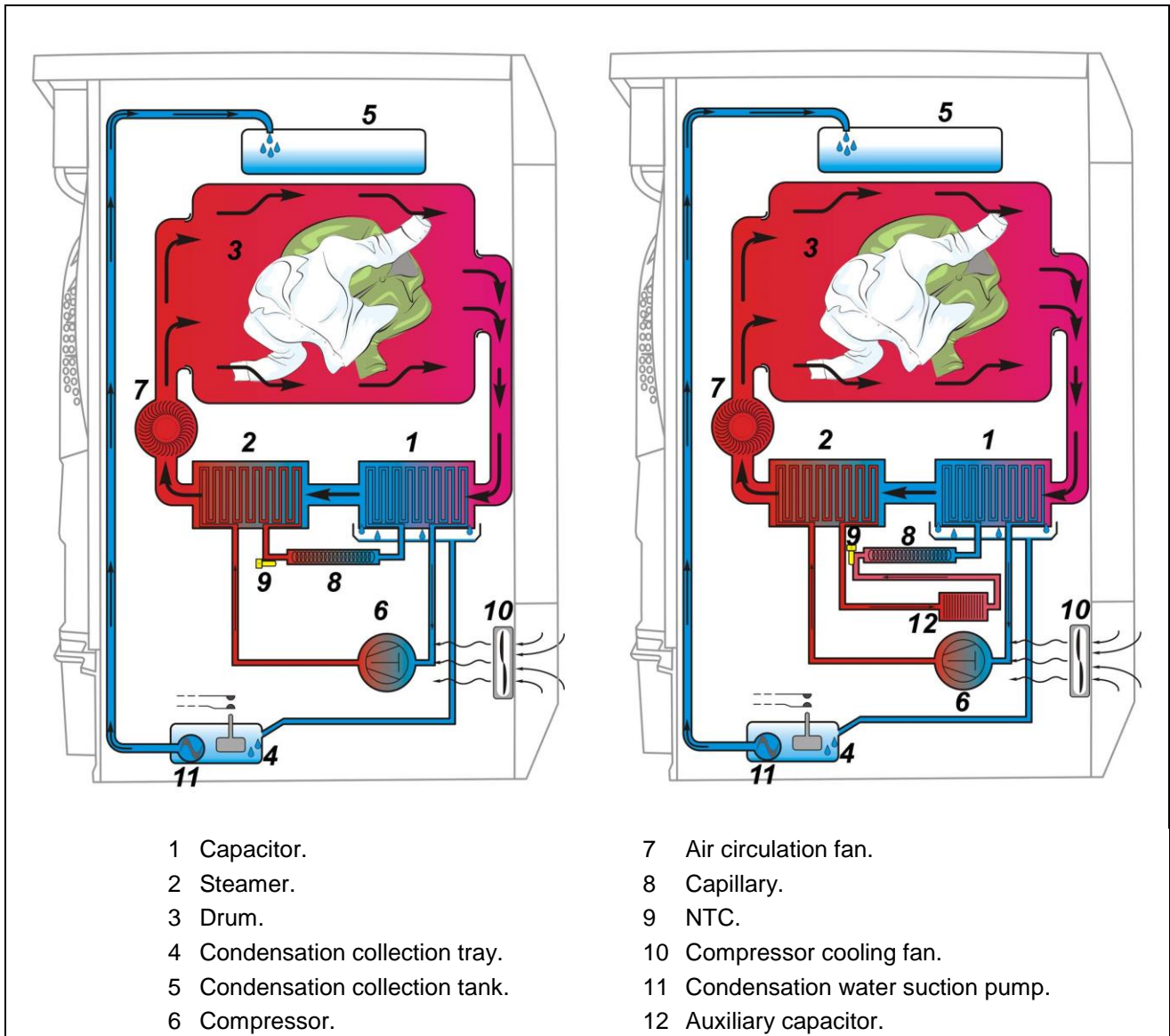

The cycle of the tumble dryer heat pump consists in evaporating, compressing, condensing and expanding the refrigerant R 407c.

By pressing the START / PAUSE button the drying cycle begins, the gas in the circuit is conveyed by the compressor (6) to the capacitor (2), where at the outlet the circulation pipe known as capillary (8) narrows. This capillary slows down the release of gas and ensures that the pressure inside the capacitor (2) increases bringing the gas to a liquid status and a pressure level of around 27 bar.

This rise in pressure subsequently increases the temperature of the gas that is now liquid inside the capacitor (2) reaching around 53 °C.

The air circulated by the fan (7) passes through this capacitor (2) overheating before entering the drum (3) where the washing is located.

The steamer (1) is located at the capillary outlet (8) with the gas circulation pipe being larger than the capillary which thus expands the hot, liquid gas coming from the capacitor (2).

This gas expansion means that the gas in its liquid state once again becomes a gaseous state causing the gas itself to cool and subsequently cooling the entire steamer, bringing it to a temperature of around 20 °C.

The, by now hot air is circulated by the fan (6) and passes through the washing in the drum (3) absorbing humidity and reaches the steamer (1) humid and hot. The latter which is now at a lower temperature thanks to the expansion of the gas ensures that all the humidity in the circulating air condenses.

The condensed water created is collected in a tray (4) and conveyed via a pump to the tank (5) located above the drum.

At this point, the air is now cold and dry and goes through the capacitor (2) again, once again overheating before entering the drum (3) and the gas now cooled in the steamer (1) returns to the compressor where it will once again be compressed and sent into the capacitor (2) re-starting the cycle.

The entire gas evaporating and compressing system is kept in balance by a NTC (9) located at the entrance to the capillary (8). This collaboration with the main circuit board ensures that if the outgoing temperature from the capacitor surpasses a certain level a fan (10) located in front of the compressor starts working and lowers the temperature.

In the models with auxiliary capacitor, the operating principle remains the same and the only single variant is in the auxiliary capacitor positioned in series to the main capacitor. This ensures that the whole system is better balanced, thus increasing performance.

3.2 Low consumption mode

In order to minimise electricity wastage when the cycle is not running, appliances in this platform offer two ways of enabling a low consumption mode:

1. Stand-Off

When the appliance is switched off at the ON / OFF button, it is in the "Stand-Off" or "virtual" off status. The LEDs and the LCD screen are turned off and the buttons are disabled, although the main circuit board and certain electrical components are electrically powered.

You have to fully unplug the appliance to cut off the power supply.

2. Automatic turn off.

Automatic turn off together with the Zero Watt circuit works as follows:

- By pressing the ON / OFF button to turn off the appliance, the supply voltage is cut off and the tumble dryer is secured (motor off, display off, etc...), the cycle and any options selected are reset, so that the next time the appliance is turned on, it is ready to perform a new programme.
- After 5 minutes, at the setting stage, no further instructions are given to the appliance and the programme and selected options are cancelled and the basic programme re-appears when turned on again.
- 5 minutes after the cycle ends, no command is sent to the appliance and all the settings are stored so that when the appliance is turned on again, the user can see if the cycle ended normally and if it should be started again.
- If an alarm goes off when a wash programme is running, the automatic off is disabled and an alarm is displayed.

These operations are carried out in order to save energy in compliance with the < 50 mW energy consumption standards.

3.3 Manufacturing characteristics

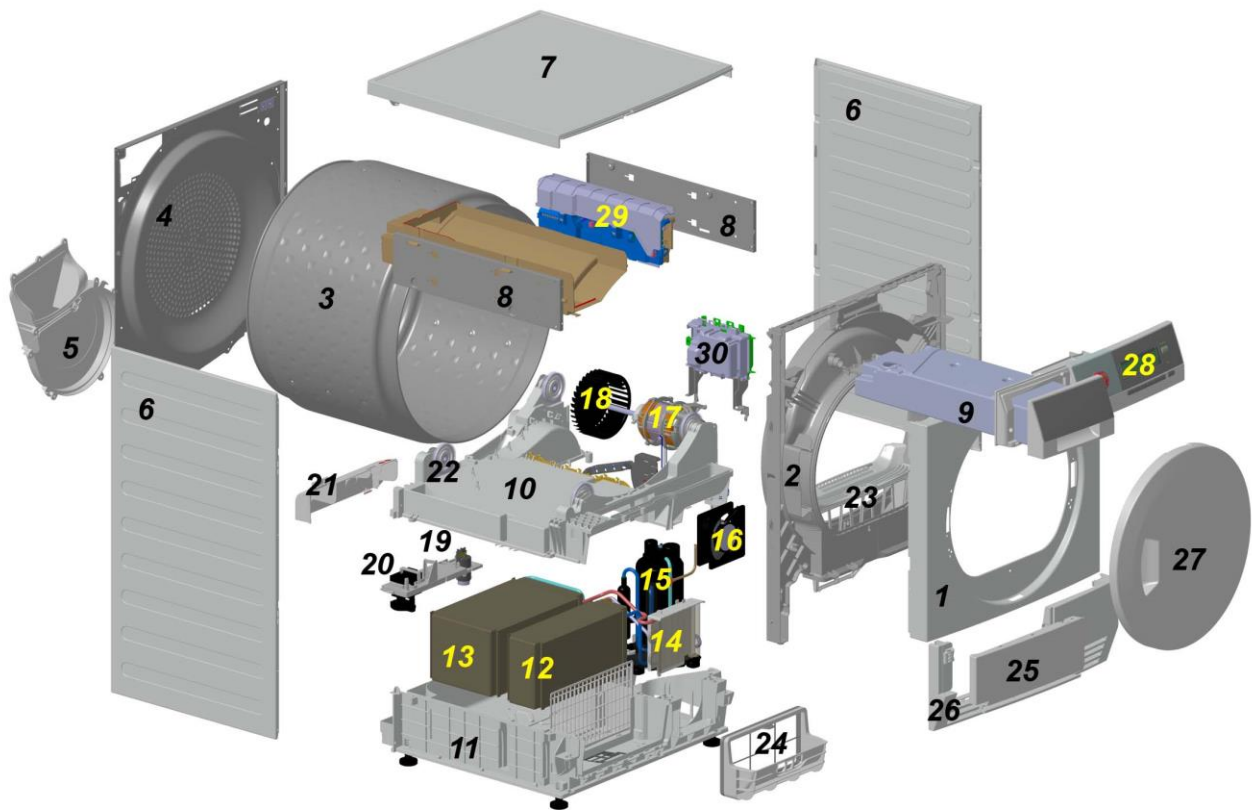

- | | | |
|----------------------------|-------------------------|--------------------------------------|
| 1. Frontal piece | 11. Base (lower part) | 21. Pump compartment lid |
| 2. Front air conduit | 12. Capacitor | 22. Drum rollers |
| 3. Drum | 13. Steamer | 23. Fluff filter |
| 4. Rear panel | 14. Auxiliary capacitor | 24. Fluff filter base |
| 5. Rear air conduit | 15. Rotating compressor | 25. Fluff filter access door |
| 6. Sides | 16. Compressor fan | 26. Base board |
| 7. Worktop | 17. Motor | 27. Door |
| 8. Crossbars | 18. Air circulation fan | 28. Control panel with control board |
| 9. Condensation water tank | 19. Level sensor | 29. Main board |
| 10. Base (upper part) | 20. Pump | 30. Motor control board |

The front panel and sides are made of painted sheet metal, whereas the rear panel is in zinc-coated sheet metal. These parts are fastened using self-tapping screws and are connected to the base.

The shaped base, in carboran, supports all the main elements.

3.3.1 Drum

The drum is made up of steel or zinc casing where inside there are three blades positioned at 120° one from the other which move the washing around during drum rotation.

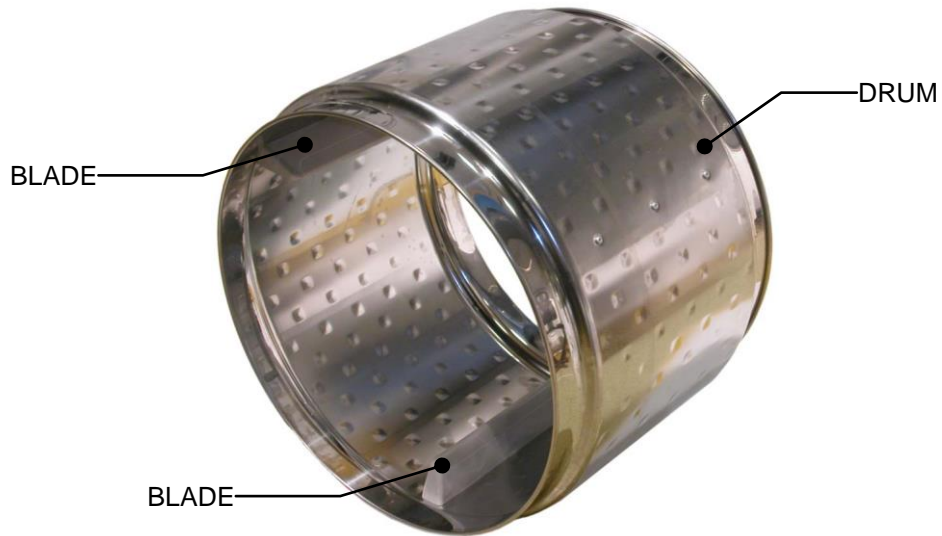

3.3.2 Air seal and drum rollers

Front air seal

1. Drum.
2. Drum rotation roller.
3. front air seal.
4. Front air conduit.

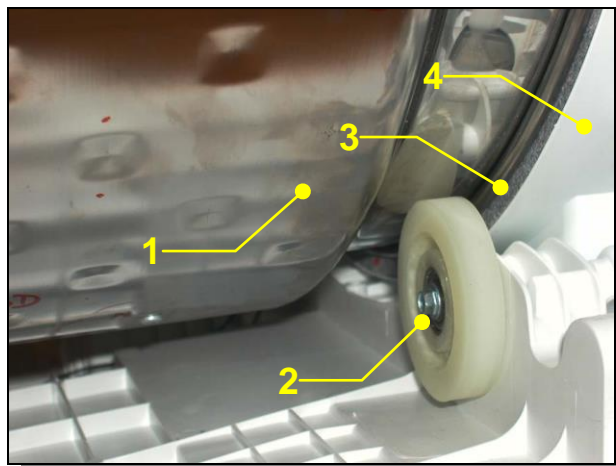

Rear air seal

5. Rear panel.
6. Rear air seal.
7. Drum.
8. Drum rotation roller.

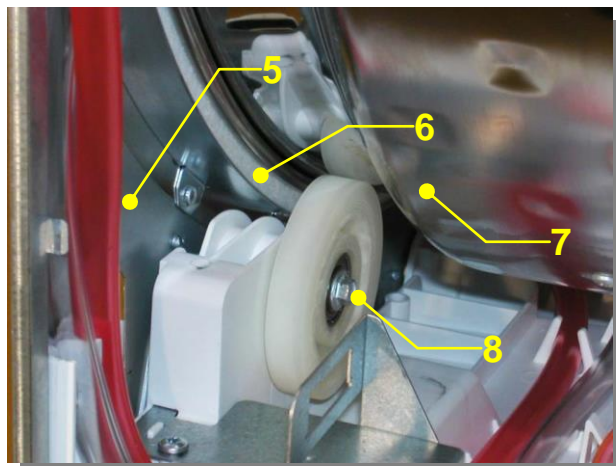

3.3.3 Water circuit

- 1 Pump immersed in the trap.
- 2 Tank water drain pipe (red).
- 3 Water overflow drain pipe (transparent).
- 4 Tank support.
- 5 Level sensor.

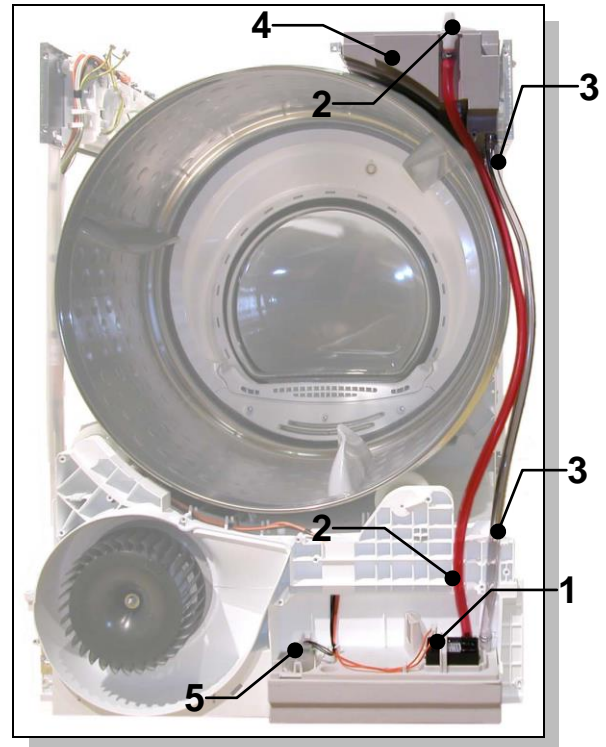

The condensation water that forms inside the exchanger is collected in a trap.

There is a float (5) inside this trap that informs the circuit board that there is water. This powers a pump (1) which conveys the water through the red pipe (2) from the trap to the tank inserted in the tank support (4).

The tank was designed to receive the condensation water of a complete cycle at full load, approximately 5.5 litres.

If, for whatever reason, the tank fills up beyond its capacity, the overflowing water is collected by the support tank and via the transparent pipe (3), is re-conveyed inside the trap pushing the float (5) upwards and this activates the micro-switch. The electronic makes 7 attempts to empty the trap within a set time, after which the electronic control recognises the problem and disconnects the power supply to the appliance and lights up a LED informing the user that the tank is full.

3.3.4 Drum rotation principle

- 1 Motor.
- 2 Inverter motor board support.
- 3 Belt tensioner spring.
- 4 Belt tensioner.
- 5 Belt.

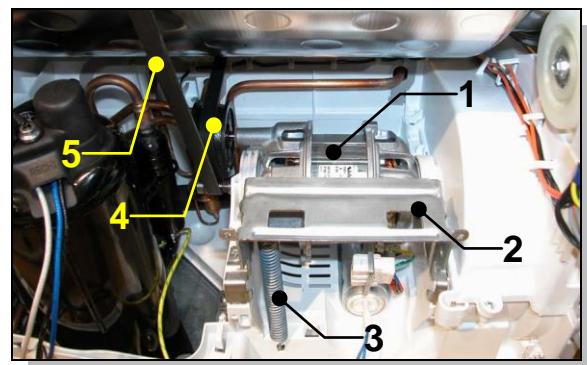

The drum is turned by a belt (5) which is driven by a motor pulley (1) fixed to the base.

There is a belt tensioner (4) on the motor casing, which increases the angle at which the belt winds onto the drum and works in a pair with the belt tensioner spring (3).

Two-way rotation of the drum is determined by the circuit board, which reverses the direction of power supplied to the motor briefly. The drum rotating in the opposite direction allows the washing to untangle.

4 Electric components

4.1 Control board

The control board or control panel is designed to allow the setting of the various programmes via the selector and to select the various options by pressing specific keys.

Depending on the appliance model, the control board can be fitted with an LCD to display the various options selected, along with the drying phases, any alarms, the time left until the end of the cycle and other information.

- A Main circuit board.
- B Control board.
- C LCD (only on series 7 - 8 - 9).
- D Selector.

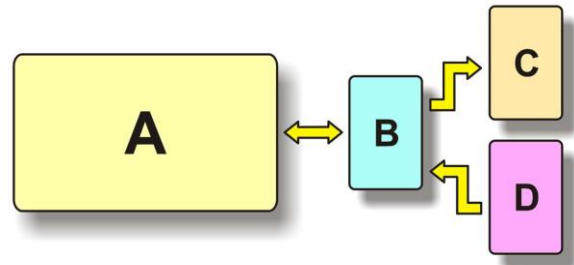

Series 6

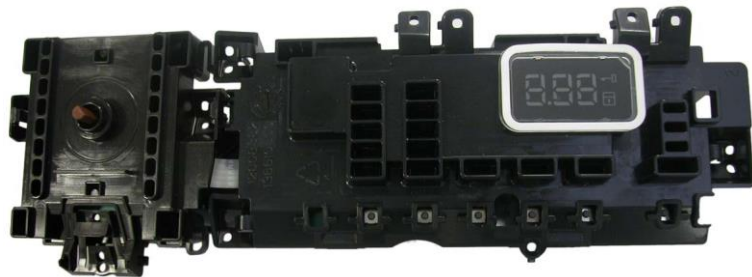

Series 7



Series 8

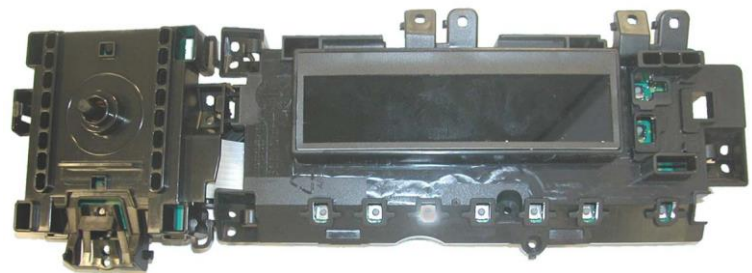

Series 9



4.2 Main electronic circuit board

- A Main circuit board.
- B Sensors.
- C Inverter motor board.
- D Actuators.
- E Control board.
- F LCD (only on certain models).
- G Selector.

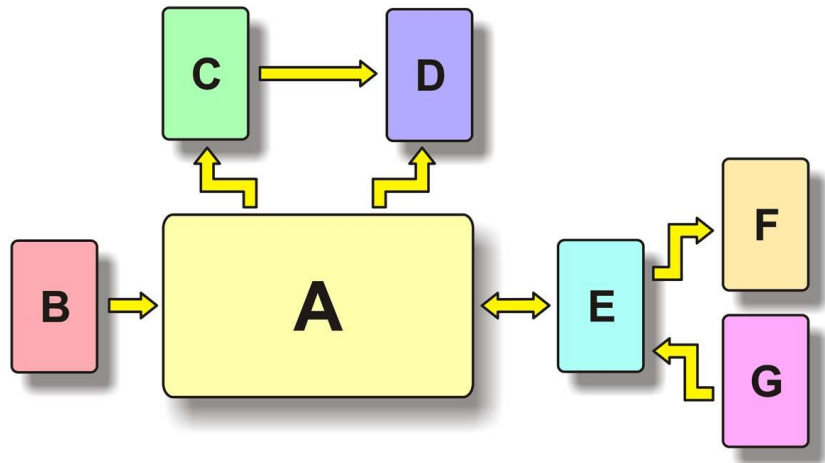

The electronic control unit is made up of a circuit board inserted in a plastic box, secured onto the top right crossbar.

This board receives information from the various sensors located on the tumble dryer and from the control board and elaborates the data and in turn controls all the actuators.

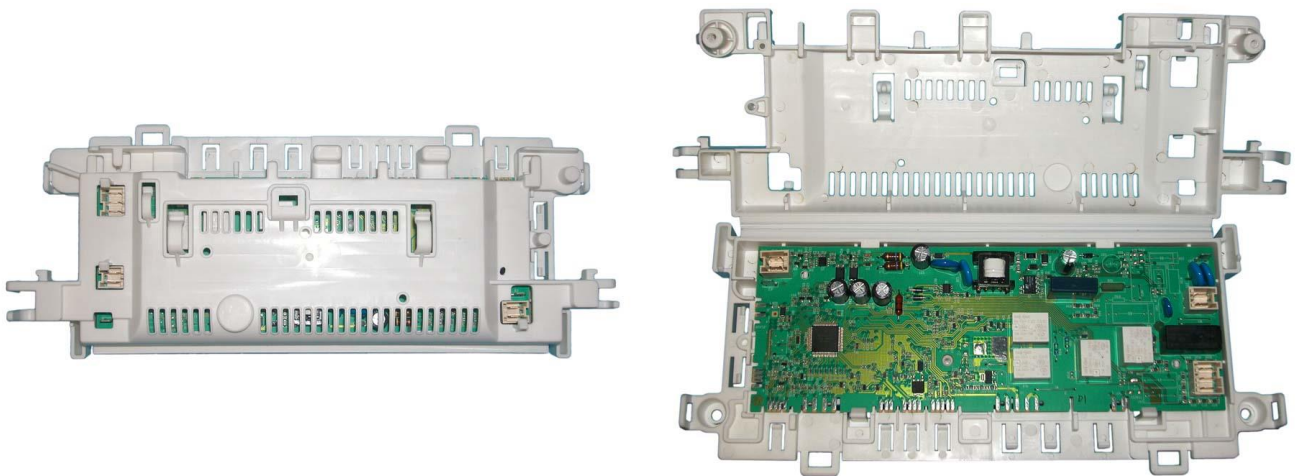

4.2.1 Main circuit board functions

- Acquires the commands for the drying cycle set-up.
- Powers up all the main components: Pump, drum rotation motor, heater unit and drum light.
- Controls the temperature of the air inside the tumble dryer (by means of an NTC probe), the humidity level in the washing (by means of the conductivity sensor), the level of the tank and the door safety lock.

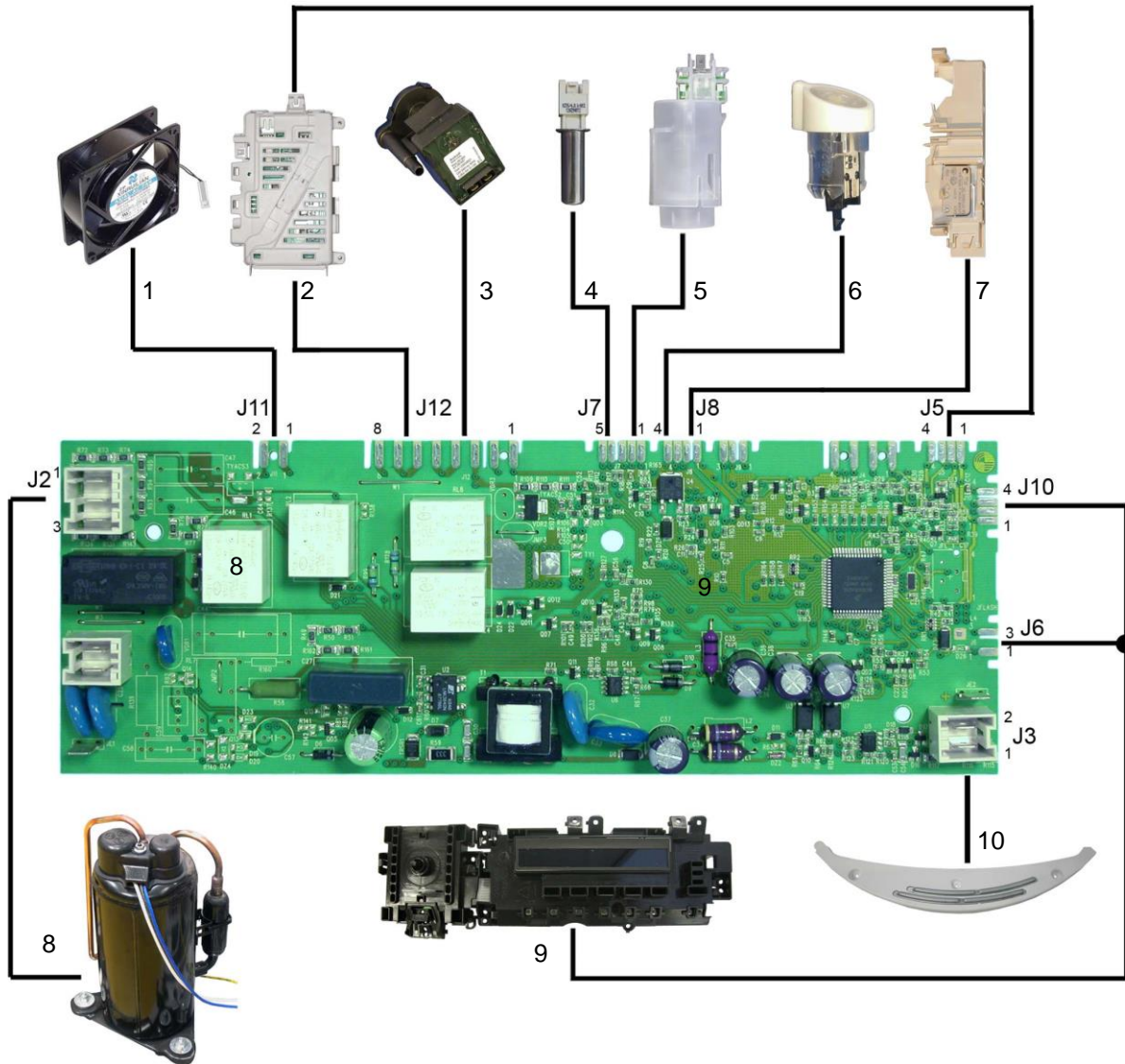

- | | |
|----------------------------------|------------------------------|
| 1. Compressor cooling fan. | 6. Drum light. |
| 2. Inverter motor control board. | 7. Door safety micro-switch. |
| 3. Condensation water pump. | 8. Compressor. |
| 4. Temperature probe. | 9. Control board. |
| 5. Level sensor. | 10. Humidity sensor. |

4.3 Inverter motor control board

- A Inverter motor control board.
- B Inverter motor.
- E Main electronic circuit board.

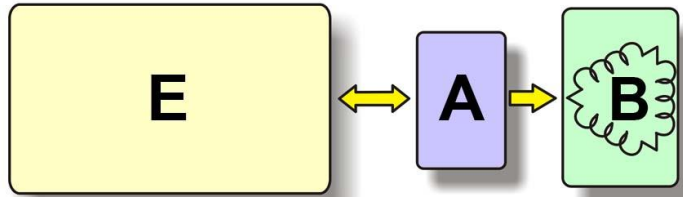

The Inverter motor control board receives the clock pulses and power from the main circuit board. It controls the drum rotation motor.

In the event of a fault, the motor is protected by the circuit board which detects greater current absorption and cuts off the power supply to the motor.

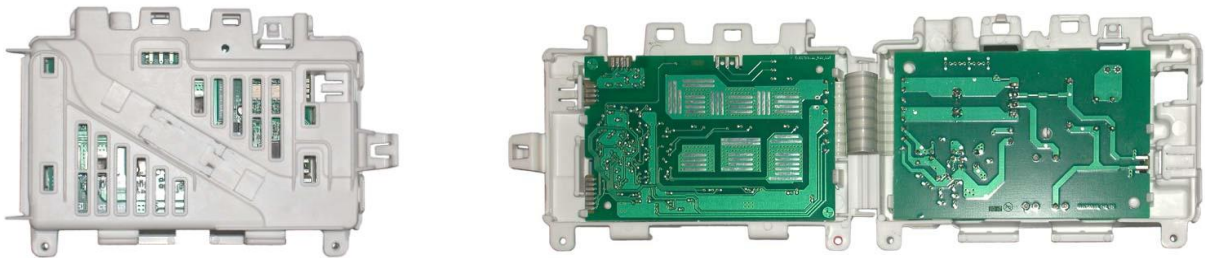

Operating principle of the Inverter motor control board.

- L Phase.
- N Neutral.
- A Inverter motor control board.
- B Motor.
- C Capacitor.
- D Diodes.
- I1-I6 Switches.
- F1-F3 Motor connectors.
- μP Microprocessor.

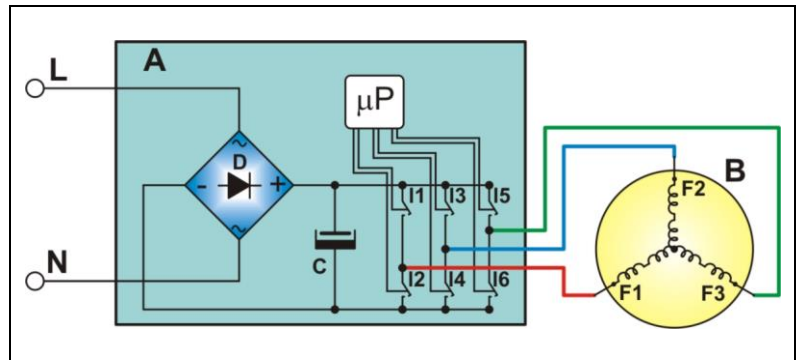

To transform the single-phase electricity (available in our homes) into three-phase electricity, a new circuit board is used (A) to transform the energy from single-phase to three-phase, which can be modulated in breadth and frequency respectively to adjust the power and number of revolutions of the motor.

Single-phase electricity (applied to connectors L-N) is rectified by the diode jumper (D), so there is a direct voltage of 310 V at the ends of capacitor C, which through the combination of the opening and closing of switches I1⇒I6 (piloted by the processor) determines the piloting voltage and frequency of the motor.

4.4 Conductivity sensor

These electronics use a conductivity sensor, comprising an electronic circuit (located inside the main circuit board) and a part outside the board comprising two sensors positioned on the front air conduit.

When the drum is empty, there is an infinite impedance between the two sensors, while its value is affected by the washing load, by the type of fabric and by the degree of humidity in the washing placed inside the drum.

The main circuit board continually receives information regarding the status of the washing in the drum via the conductivity sensor as well as the settings made by the operator at the start of the cycle via the control board and elaborates these values in order to establish the time needed at the end of the cycle.

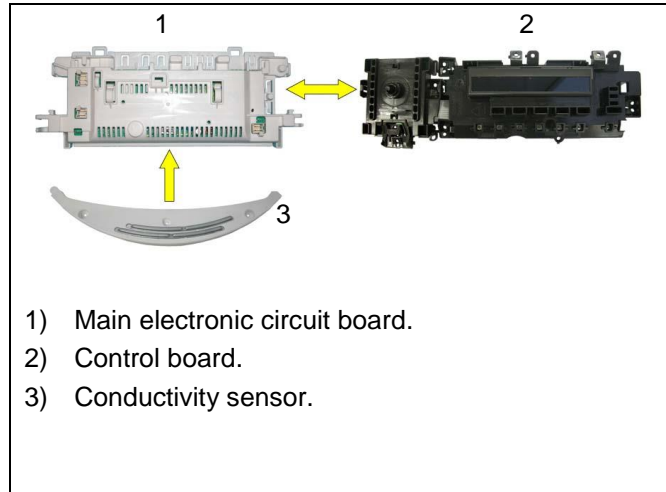

4.5 Tank filling pump

The pump is activated by a synchronous motor and is used to pump condensation water from the tray to the tank.

The pump is powered by a triac on the main board.

Insulation class	155
Motor type	Asynchronous
Volt (V AC)	220-240
Frequency (Hz)	50 Hz
Power (W)	5 W
Resistor at 20 °C	764 Ω \pm 10%



4.6 Level sensor

The condensation water level sensor is located at the back of the tumble dryer and next to the tank loading pump.

It consists of a float with a magnet at the top and a reed switch positioned on the float guide / support.

When the water forming on the heat exchanger (capacitor) falls into the collection tray this causes the float to rise up subsequently bringing the magnet closer to the reed switch which sends a signal to the main circuit board activating the tank loading pump.



4.7 NTC probe

This sensor is fixed to the hot air fan screw. It comprises a heating element, inserted in a metal capsule, with a value that decreases as the temperature rises. The electronic circuit reads the value of the heating element (which depends on the temperature inside the tumble dryer) and when it drops below a certain value, cuts the power supply to the heater unit. As the air cools, the value of the heating element increases, and when it reaches a certain value the electronic circuit restores the power supply to the heater unit. This occurs every time the temperature inside the appliance exceeds a given value, which varies according to the drying cycle that has been selected.

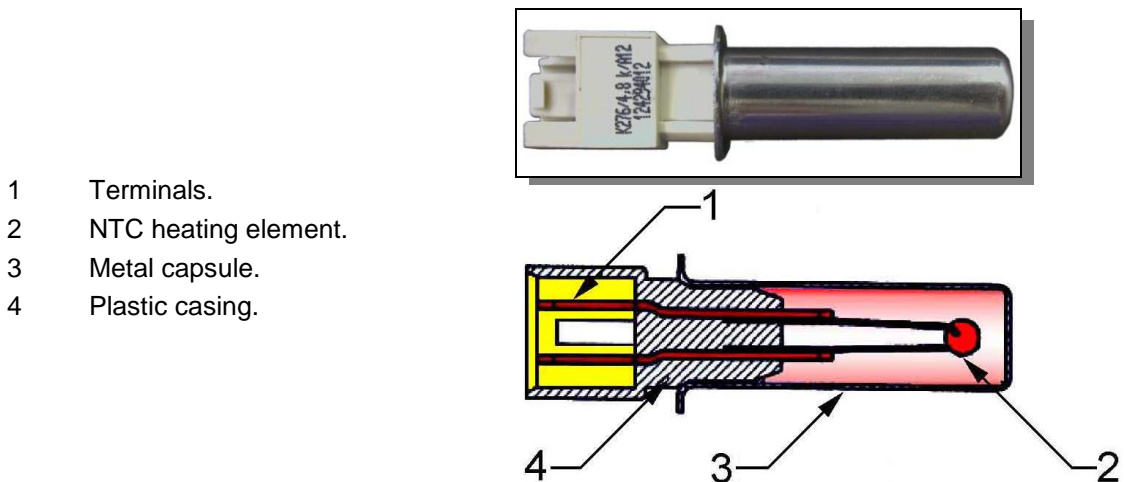

Temperature (°C)	Heating element Ω		
	Rated value	Maximum Value	Minimum value
20	6,050 – 5,617	6,335 – 5,686	5,765 – 5,548
60	1,393 – 1,250	1,419 – 1,222	1,367 – 1,278
80	725 - 640	743 - 620	707 - 660

4.8 Drum light

The drum light consists of a high luminosity LED diode inserted in a plastic support and fitted onto the front air conduit.

The lamp is powered directly by the main circuit board when the door is opened with a voltage of 5 V.

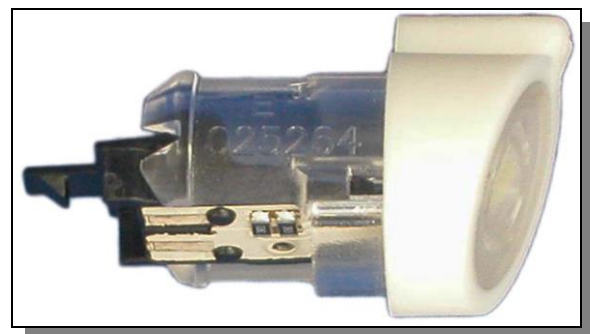

R1	3.3 Ω
R2	3.3 Ω
Current	150 mA
Power	3.3 V

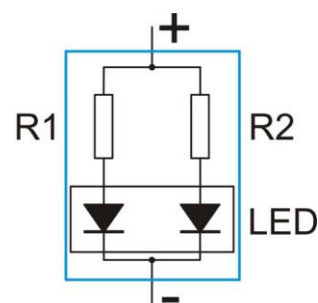

4.9 Compressor

The compressor activates the coolant fluid circuit (R407c).

Power supply voltage	220 V 50 Hz
Power consumed	480 Watt
Main coil resistance	$6.84 \Omega \pm 7\%$
Auxiliary coil resistance	$5.88 \Omega \pm 5\%$
Overall weight	8.5 kg
Oil	210 cm ³ +-10 cm ³ NMOC Ze – Gles RB68EP



- A Line.
- B Heat protection.
- C Run capacitor.
- D Auxiliary coil.
- E Primary coil.

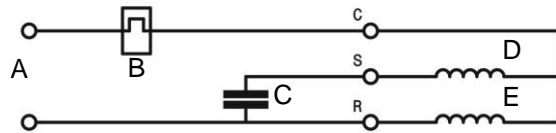

4.10 Thermal cut-out

The heat protection is formed by a bimetallic which intervenes when the motor - due to excess effort - increases current absorption and consequently rises in temperature.

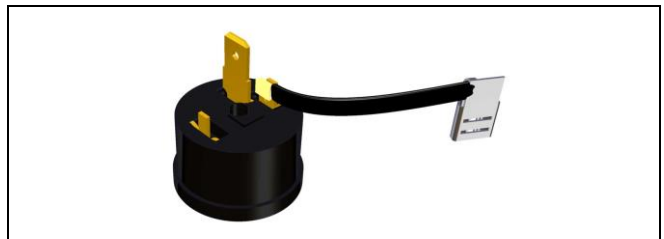

4.11 Compressor motor capacitor

The capacitor enhances the performance of the compressor motor.

18 μ F 400 V



4.12 Compressor cooling fan

Axial fan on ball bearings

Power supply voltage	132-240 V
	50-60 Hz
Power consumed	23 W
Rotating speed rpm	2,600 / 3,000
Air flow at 2,600 rpm	2.32 m ³
Air flow at 3,000 rpm	2.72 m ³



4.13 Door micro-switch

The door switch makes it possible for the electric components to be powered after the door has been closed. The switch is located above the door and it is closed, when the door itself is closed, by means of a pin located on the door itself.



4.14 Motor

The asynchronous three-phase motor used in this tumble dryer has permanent magnets and is driver directly by the inverter motor control board, which in turn receives commands from the main circuit board.

- 1 Fan.
- 2 Belt tensioner.
- 3 Motor.
- 4 Vibration damping bushes.

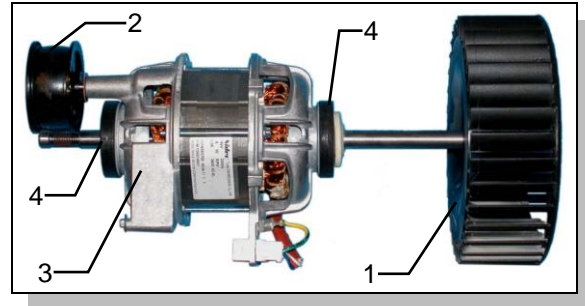

The motor unit consists of a belt tensioner (2) situated on an axis on the motor casing and secured by a spring ring, with one fan (1) for the circulation of hot air, bolted to the motor shaft, of the motor (3) with thermal cut-out and two vibration damping bushes (4) positioned on the two motor casings. The motor power connector is located on a shaft fixed to a casing.

Calmed

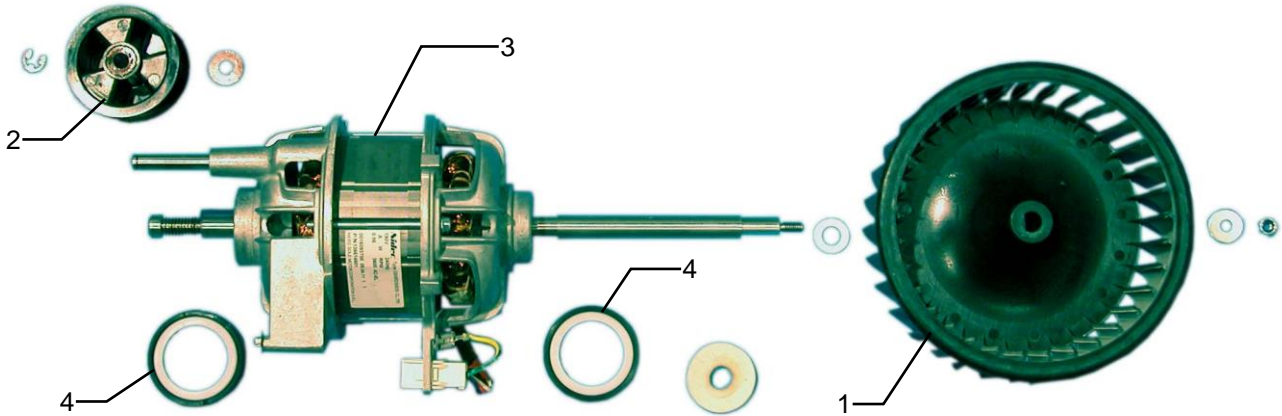

4.14.1 Asynchronous three-phase or Inverter motor technical details

Power supply voltage	230 V
Frequency	50 Hz
RPM	2,700
Coil resistance 1 - 2	20.4 $\Omega \pm 7\%$ at 20 °C
Coil resistance 1 - 3	20.4 $\Omega \pm 7\%$ at 20 °C
Coil resistance 2 - 3	20.4 $\Omega \pm 7\%$ at 20 °C

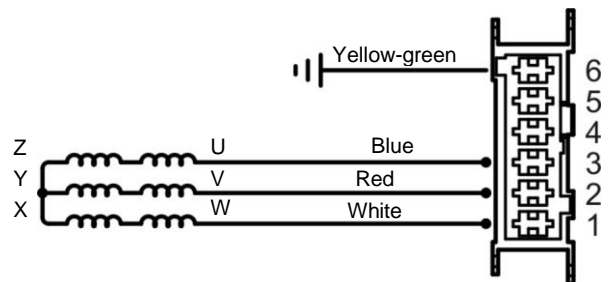

Wiring diagram

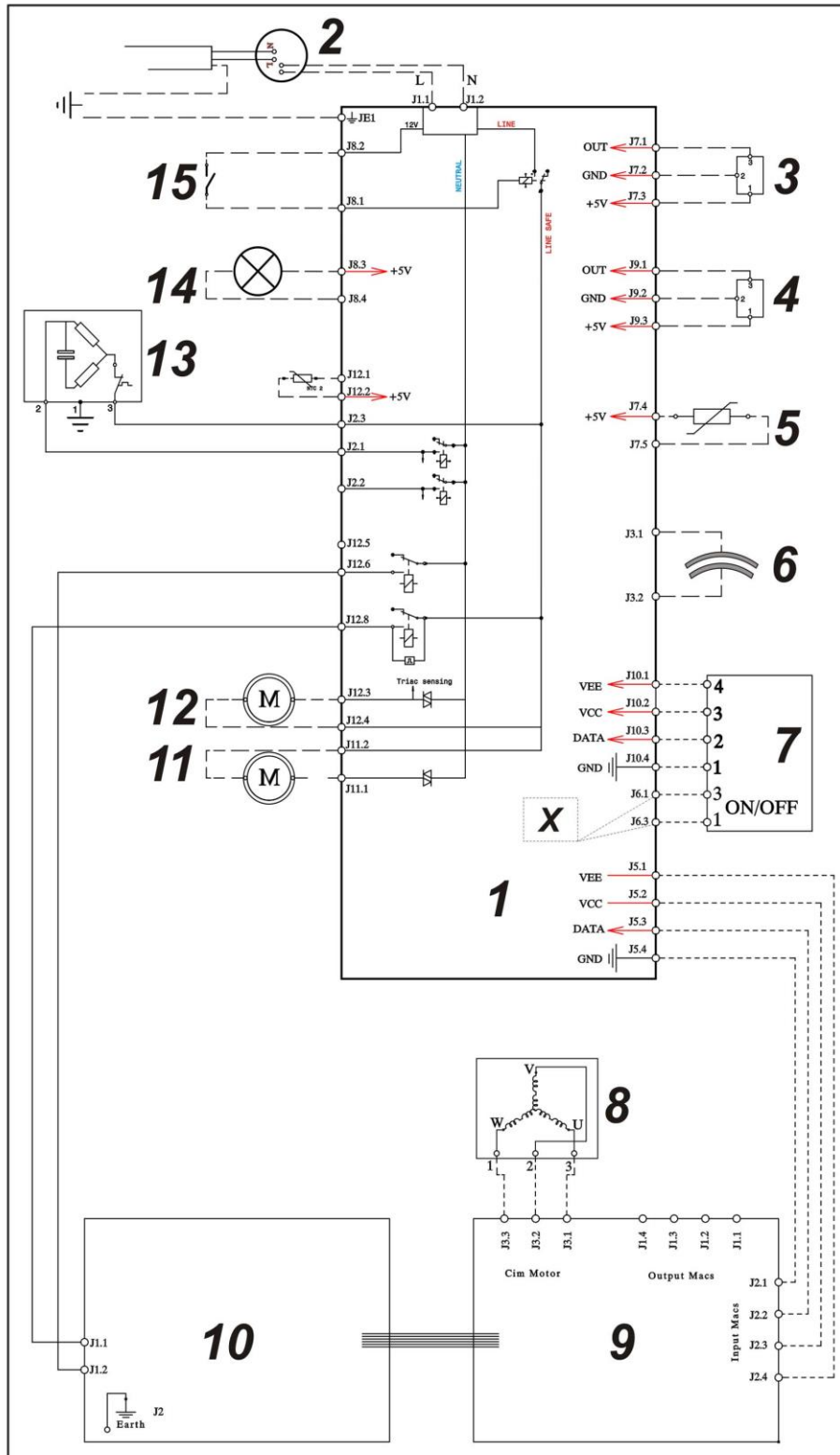

- | | |
|--|-------------------------------------|
| 1. Main board. | 9. Inverter board (motor piloting). |
| 2. Anti-disturbance filter. | 10. Inverter board. |
| 3. Water collection tray micro-switch. | 11. Compressor fan. |
| 4. Filter sensor. | 12. Condensation water pump. |
| 5. Temperature probe. | 13. Compressor. |
| 6. Humidity sensor. | 14. Drum light. |
| 7. User interface card. | 15. Door safety micro-switch. |
| 8. Drum rotation motor. | X Not used in series 6 and 7. |

5 Selector dial positions in diagnostics



The alarms are enabled during diagnostic testing of components. If an alarm appears, move the selector to the first position to exit the alarm status and, if necessary, continue the test (if the alarm is not triggered again).

To check the correct functioning of the float switch and pump, the trap should be filled with approximately 0.7 litres of water.

In order to test the conductivity sensor properly in case of a short-circuit (position 8), a short circuit must be created between the two sensors on the front air conduit before moving the selector dial to the eighth position. If the short-circuit is not created properly, the circuit board will display alarm E32 (sensor frequency too low). To exit this alarm, move the selector to the first position.

Position 1

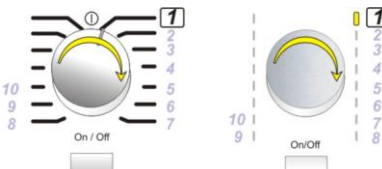
User interface test	Purpose of the test:	To test the functionality of all LEDs and switches.
	Components activated:	All LEDs. LCD display.
	Behaviour:	All LEDs flash in sequence. Press a button and the corresponding LED is lit; the code is shown on the LCD display and the buzzer sounds. All LCD icons flash simultaneously.
	Working conditions:	There is a control to run the test (always active).

Position 2

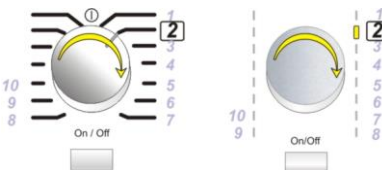
Float micro-switch and condensation water pump	Purpose of the test:	To test the pump and micro-switch situated in the condensation water tray.
	Components activated:	If the condensation water collection tray is full and the micro-switch detects this condition, the pump is started.
	Behaviour:	If the water level in the tray is low, the LCD displays III and if the level is high (micro-switch triggered), the LCD displays 000.
	Working conditions:	Door closed (time out 10 secs.).

Position 3

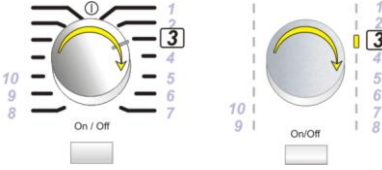
Anti-clockwise drum rotation	Purpose of the test:	To test the drum rotation motor in an anti-clockwise direction.
	Components activated:	Motor TRIAC. Anti-clockwise direction relay. Drum rotation motor. Condensation water filling pump.
	Behaviour:	The motor turns the drum anti-clockwise and the condensation water filling pump is in operation.
	Working conditions:	Door closed (time out 10 mins.).

Position 4

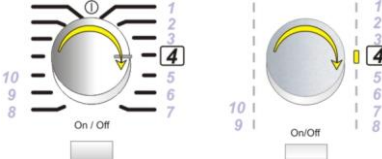
Compressor cooling fan	Purpose of the test:	Test operation of the compressor cooling fan.
	Components activated:	Compressor cooling fan TRIAC. Safety relay.
	Behaviour:	LCD indicates the position of the selector.
	Working conditions:	Door closed (time out 10 mins.).

Position 5

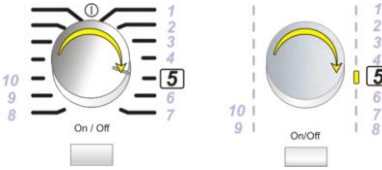
Clockwise drum rotation	Purpose of the test:	To test clockwise rotation of the drum.
	Components activated:	Clockwise drum rotation motor. Safety relay.
	Behaviour:	LCD indicates the position of the selector. The drying temperature NTC1 is displayed on the LCD.
	Working conditions:	Door closed (time out 10 secs.).

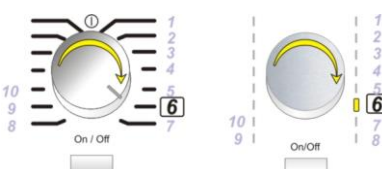

Position 6

Compressor and clockwise drum rotation	Purpose of the test:	To test compressor operation.
	Components activated:	Compressor. Clockwise drum rotation motor.
	Behaviour:	LCD indicates the position of the selector. The drying temperature NTC1 is displayed on the LCD.
	Working conditions:	Door closed (time out 10 secs.).

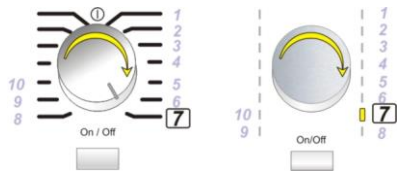
Position 7

Open-circuited conductivity sensor	Purpose of the test:	To check the conductivity sensor in open-circuit conditions.
	Components activated:	Conductivity sensor.
	Behaviour:	<p>The test lasts 4 seconds, during which the LCD flashes, displaying 000.</p> <p>At the end of the test, the LCD stops flashing and displays III.</p> <p>If the test was unsuccessful, the LCD continues to flash, displaying.</p>
	Working conditions:	Conductivity sensor free from any garments or contact.

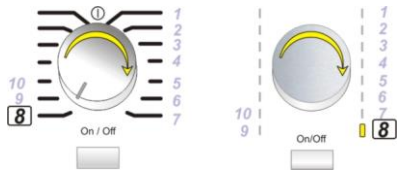
Position 8

Closed circuited conductivity sensor	Purpose of the test:	To verify conductivity sensor in short circuit condition.
	Components activated:	Conductivity sensor.
	Behaviour:	<p>The test lasts 4 seconds, during which the LCD flashes, displaying 000.</p> <p>At the end of the test, the LCD stops flashing and displays III.</p> <p>If the test is unsuccessful, the LCD displays the alarm E32.</p>
	Working conditions:	Short-circuited conductivity sensor.
		Create a short circuit between the two sensors on the front air conduit before setting the selector dial to the eighth position.

Position 9

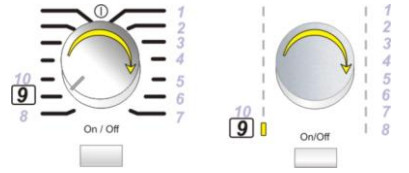
Condenser Tank Switch	Purpose of the test:	To test the micro-switch under the condensation water collection tray.
	Components activated:	If the condensation water collection tray is full and the micro-switch detects this condition, the pump is started.
	Behaviour:	If the water level in the tray is low, the LCD displays III and if the level is high (micro-switch triggered), the LCD displays 000.
	Working conditions:	Door closed (time out 10 secs.).

Position 10

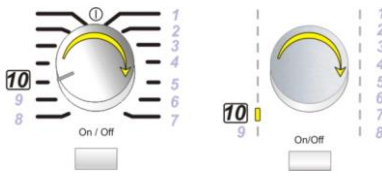
Last alarm display and possible reset	Purpose of the test:	To see the alarm and delete it.
	Behaviour:	The LCD display flashes and shows any alarm present.
	Working conditions:	Turn the dial to position 10, paying attention not to stop in position 8 in order to avoid error 32. Press the START / PAUSE button to see all the alarms present. To delete the alarms, hold down the START / PAUSE buttons and press the button on the left.

Position 11 and subsequent positions

Last alarm display and possible reset		
	Behaviour:	All LEDs flash in sequence. Press a button and the corresponding LED is lit; the code is shown on the LCD display and the buzzer sounds.
	Working conditions:	Door closed (time out 10 secs.).

6 Access to components

6.1 Upper fluff filter cleaning

- Open the door.
- Pull the fluff filter upwards to remove it.
- Open it and remove all fluff.
- Any residual fluff should be removed by washing the filter under running water.



6.2 Capacitor filter cleaning

- Open the door.
- Move the locking lever towards the right.
- Open the door in the kick plate.
- Rotate the locking lever clockwise and open the door.



- Pull the filter outwards to remove it.
- Clean it and if necessary wash under running water taking care not to damage it.

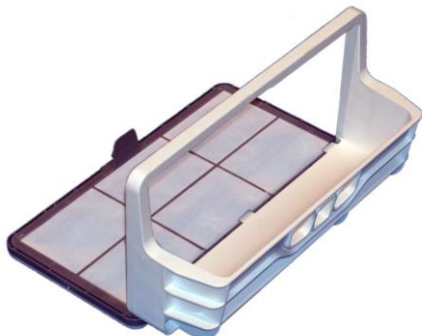

6.3 Clean condensation water filter

- Remove the capacitor filter.
- Lift the condensation water filter up slightly.
- Remove and wash it.

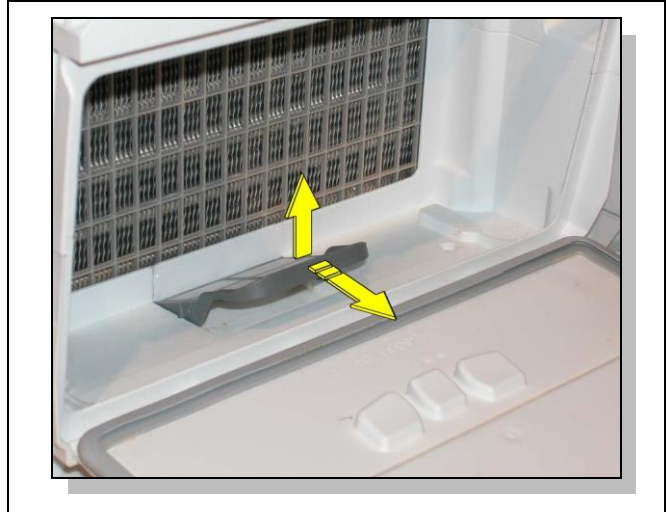
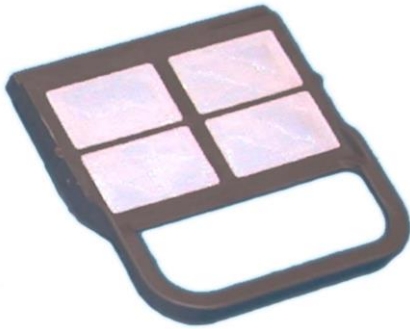

6.4 Worktop

- Loosen the 2 rear fixing screws.



- Remove the tank.
- Loosen the front fixing screw.
- Move the worktop towards the rear and remove it.



6.5 Sides

- Remove the worktop.
- Loosen the screws that secure the sides to the top crossbars.

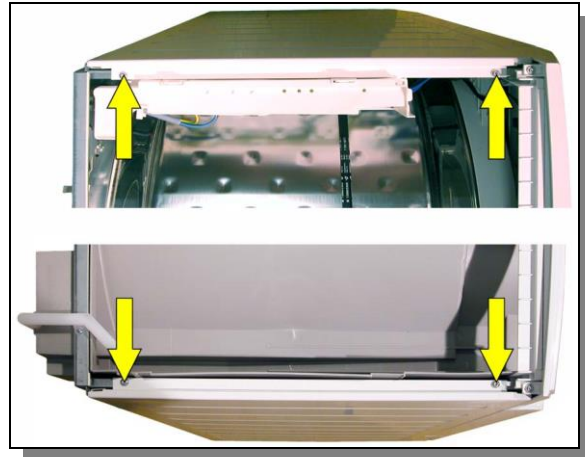

- Unscrew the 4 screws for each side located at the back of the tumble dryer.

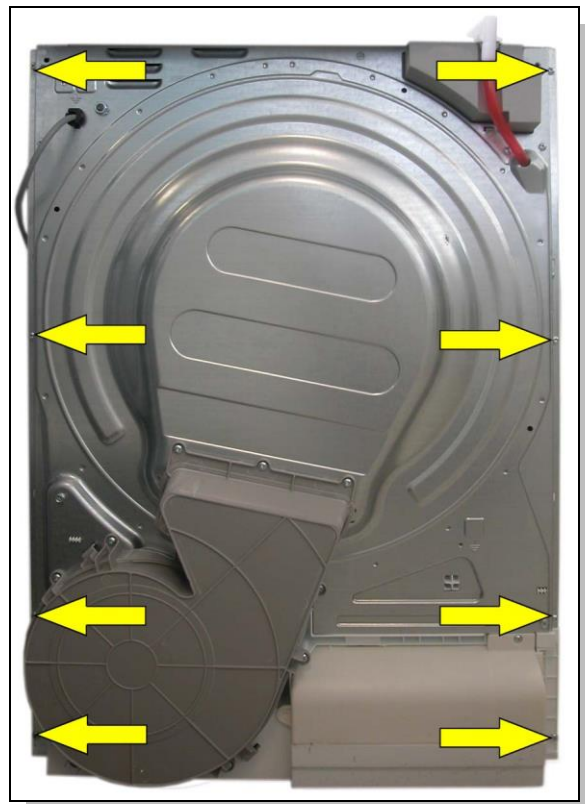

- Slightly lift up the panel to ensure that the fixing catch located in the tumble dryer comes out of pocket located in the panel.



6.6 Main electronic circuit board

- Remove the worktop.
- Remove the right side panel.
- Unhook the board protection fitting clips and remove them by pulling them upwards.

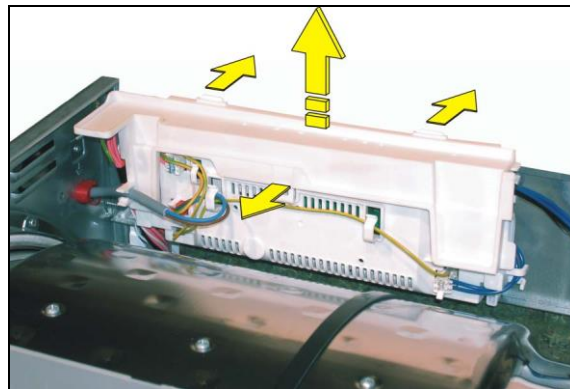

- Disconnect all connectors, making a note of their positions.
- Remove the two fastening screws from the crossbar.
- Move the entire board assembly towards the control panel so as to unhook and remove it.

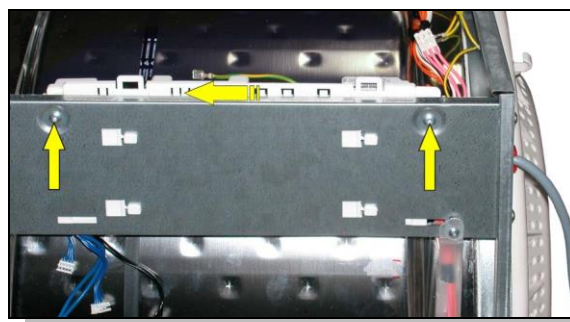

6.7 Panel de control

- Remove the worktop.
- Remove the tank.
- Loosen the three screws securing the control panel to the uprights and air conduit.



- Loosen the 2 screws that secure the control panel to the tank support.

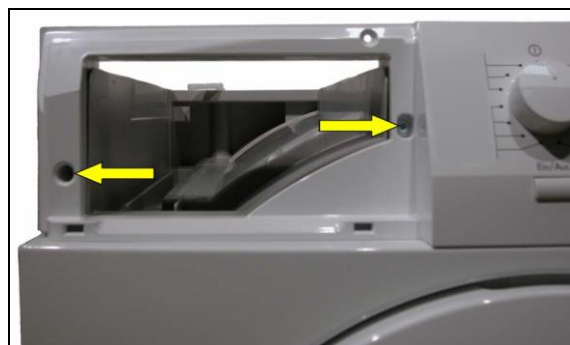

- Rotate it forwards.
- Remove the wiring, making a note of the position of the various connectors.
- Remove the entire control panel.

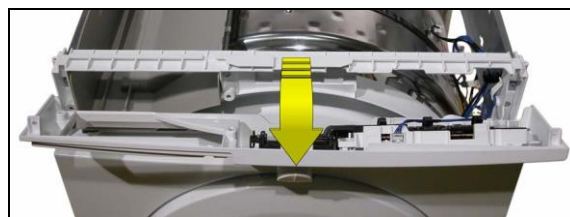

6.7.1 Control board

- Loosen the 9 fastening screws on the board.

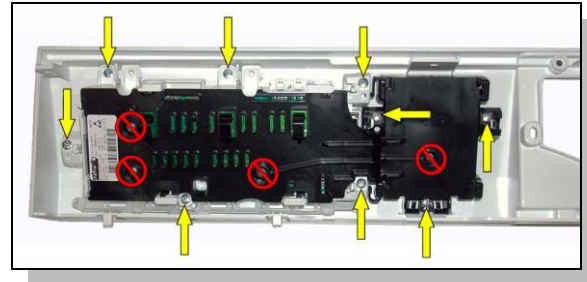

- Using a screwdriver unhook the 10 fixing clips and simultaneously lift up the whole board unit until it has been completely removed.

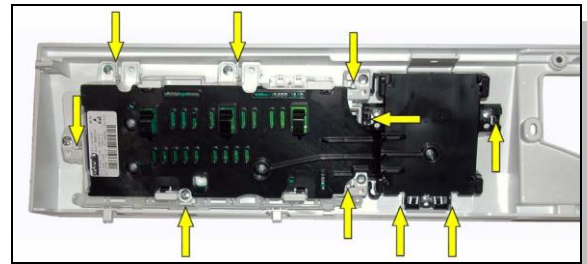

6.7.2 Programme selector knob series 6

- Press the 4 anchoring clips inwards and simultaneously push the handle outwards.

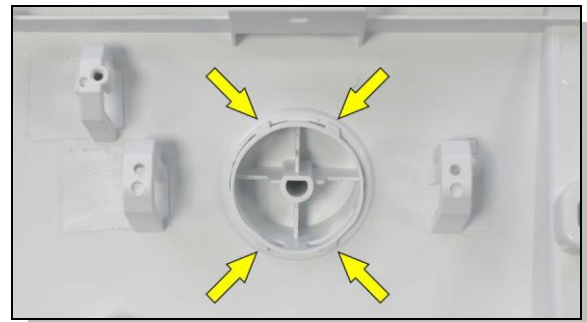

6.7.3 Programme selector knob series 7-8-9

- With the aid of a screwdriver press the three locking clips on the knob cover inwards.
- Simultaneously pull the knob cover until it is completely removed.

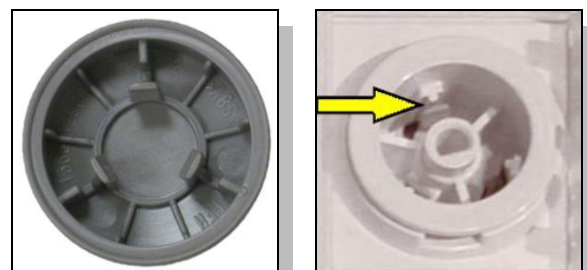

6.7.4 Buttons spring and LED light diffuser

- Using a screwdriver unhook the 3 fixing clips taking care not to damage the locking slots and simultaneously lift up the button springs in order to remove them.



In order to remove the LED light diffuser from its seat, first remove the buttons spring.

- Move the two fixing clips slightly and remove the LED light diffuser.

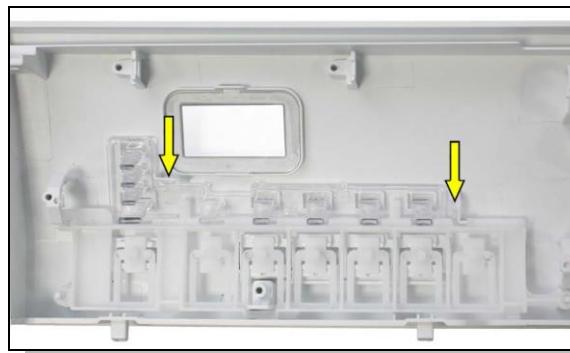

6.7.5 Buttons

After the buttons spring has been removed, each button can be removed individually.

Each button has its position printed on it.

Only the ON / OFF and START / PAUSE buttons do not have a number printed on them because they are different and can only be fitted in their position.



6.8 Door

To remove the dryer door, irrespective of whether it is a plastic dummy door or in transparent glass, proceed as follows:

- Unscrew the 2 screws that hold the door to the front.
- Lift up slightly so that the hook unhooks and remove it.



Caution: the glass door weighs approximately 4.5 kg

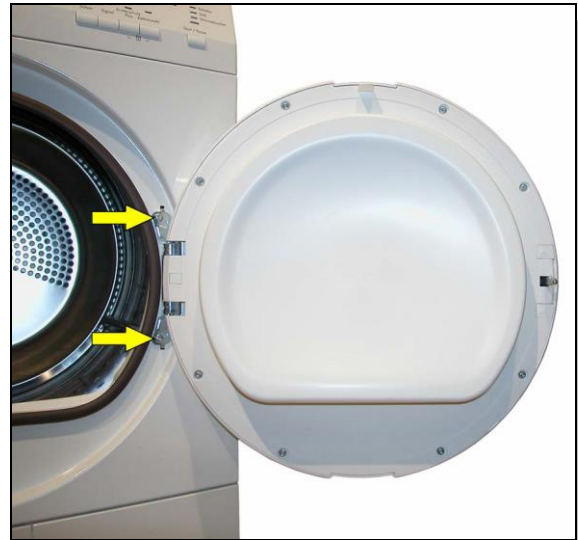

6.8.1 Plastic door handle, latch and hinge

- Unscrew the 8 perimetral screws on the door and remove the internal cover.
- Using a screwdriver and taking care not to damage the frame, remove the door U joint.



- Loosen the 2 screws securing the hinge and remove it.
- Pull out the pin securing the hinge and latch and remove them.

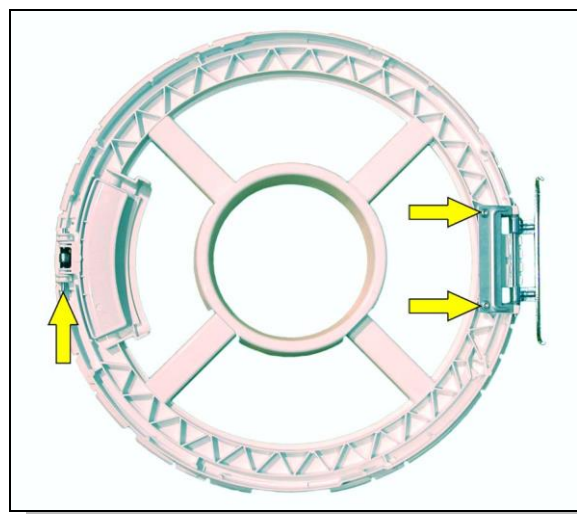

6.8.2 Plastic door micro switch lever

- Insert the door microswitch lever so that the reference pocket is positioned towards the inside of the internal frame so that it lines up with the notch in the external frame.

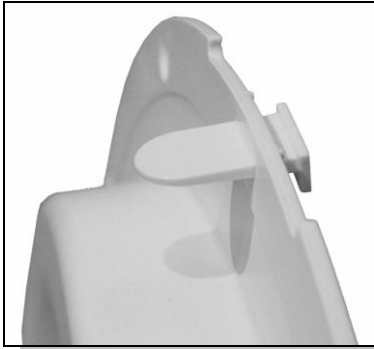

6.8.3 Glass door handle, latch and hinge

- Unscrew the 4 perimetral screws that attach the hinge unit to the door.
- Using a screwdriver and taking care not to damage the frame, remove the whole hinge unit.

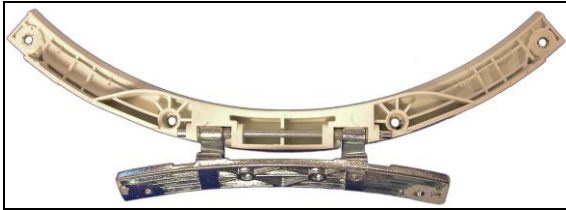

- Unscrew the remaining 8 screws that hold the frame to the door and remove it.
- Loosen the two screws securing the handle assembly and remove it by pushing it out.

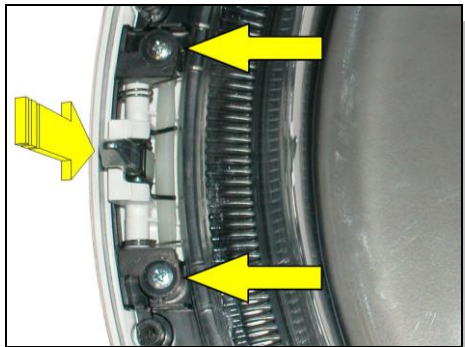

6.8.4 Glass door micro-switch lever

- To remove the door micro-switch lever, press the fastening clip.
- Push the lever in the direction shown by the arrow until you have removed it completely.
- Insert the lever as far as it can go to re-assemble it so that the fastening clips block it.

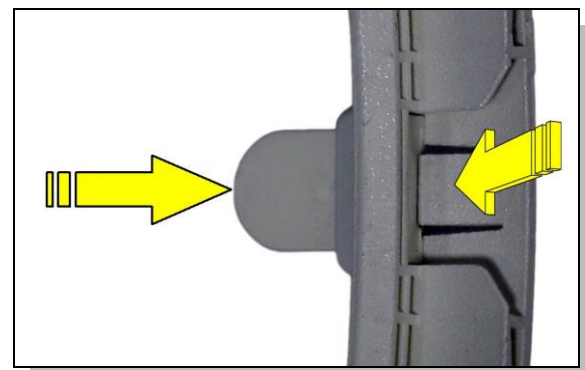

6.9 Level sensor and condensation water pump

- Loosen the screws that hold on the level sensor compartment lid and pump.
- Unhook the fastening clip.
- Remove the protection.



6.9.1 Level sensor

- Detach the connector and remove it.
- Slightly move the locking hooks indicated by the arrows and remove the level sensor by pulling it upwards.

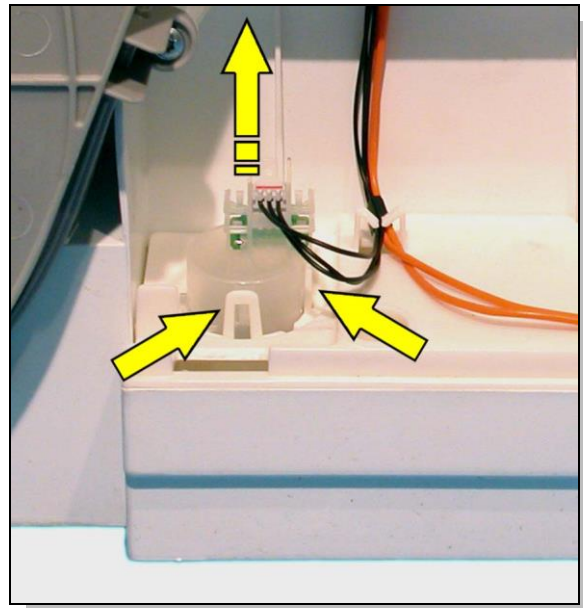

6.9.2 Condensation water pump

- Using pliers, loosen and raise the clamp securing the red pipe (supply) and raise it a few centimetres.
- Repeat the operation with the transparent pipe (comes back too full).

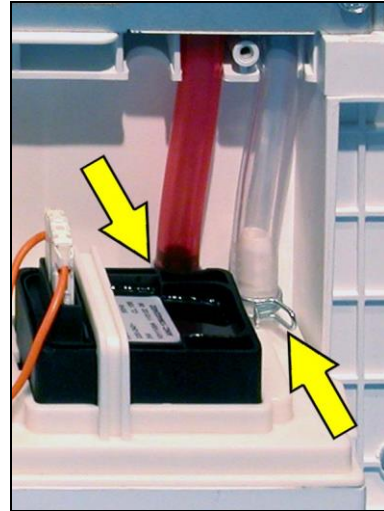

- Disconnect the 2 pump connectors and the level sensor connector.
- Loosen the screw that holds the whole pump and level sensor to the machine and remove it.



- Insert a screwdriver in the slots indicated by the arrows and remove the pump by pushing it down.

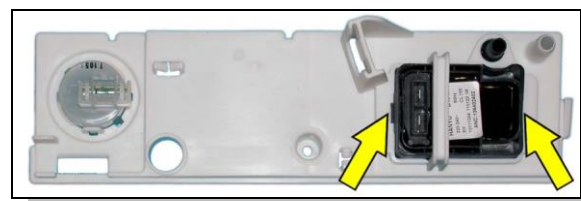

6.10 Inverter board and three-phase asynchronous motor

- Remove the worktop.
- Remove the right side panel.
- Loosen the 2 screws securing the Inverter motor control board and remove it by raising it slightly and pulling it outwards.



- Loosen the 10 screws that hold the rear air conduit.
- If necessary, use a screwdriver to unhook the clips that hold it and remove it.

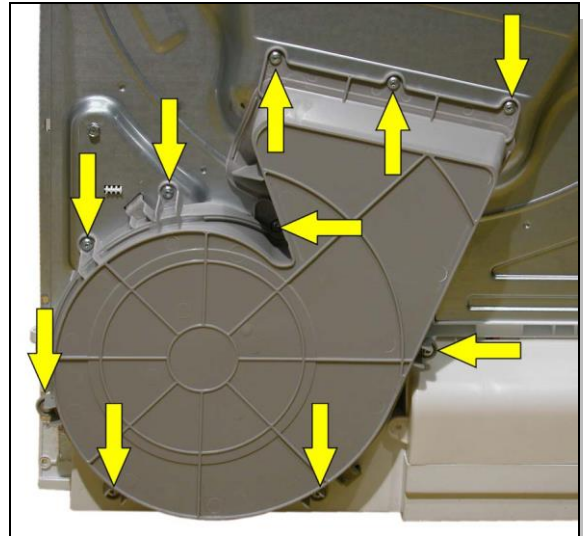

- Loosen the bolt that holds the hot air circulation fan.
- Remove it by pulling it outwards.

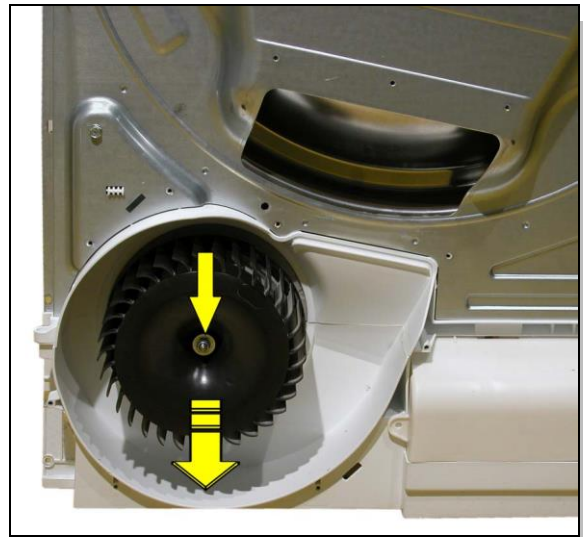

- Loosen the 2 screws that hold the inverter motor board support rod.
- Pull it upwards and remove it.

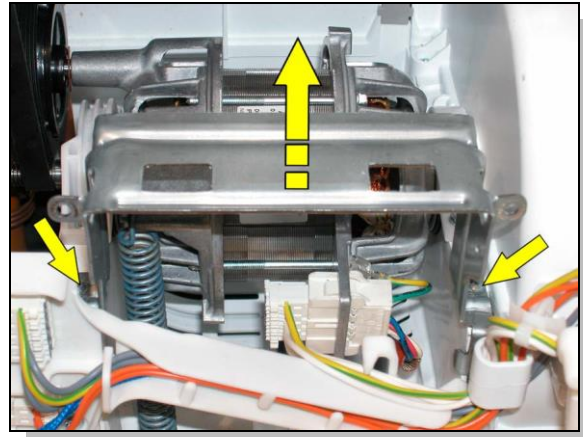

- Disconnect the motor connector.
- Using a pair of pliers, detach the spring that keeps the tensioner spring under tension.
- Remove the belt from the tensioner belt and motor axis.
- Loosen the screws that hold the front and rear motor fastening rods, lift them up by rotating them and remove them by pulling them off the rear hook.

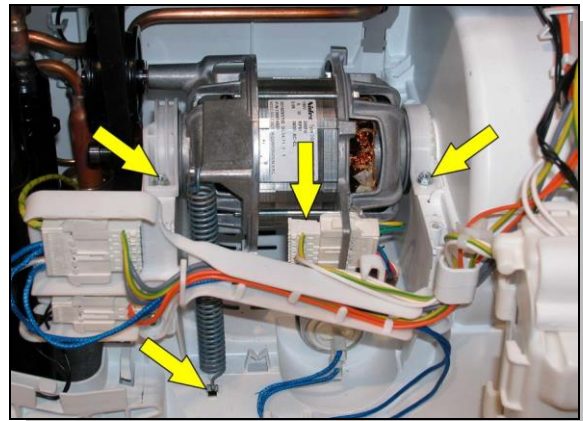

- Slightly rotate the whole motor unit.
- Lift it up and remove.

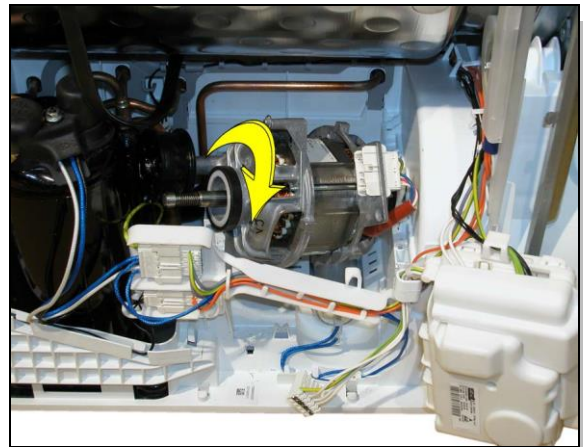

6.11 Rotating compressor running capacitor

- Remove the worktop.
- Remove the right side panel.
- Remove the drum rotating motor.
- Disconnect the 2 connectors.
- Loosen the screws that hold the capacitor in its slot and remove it by pulling it upwards.

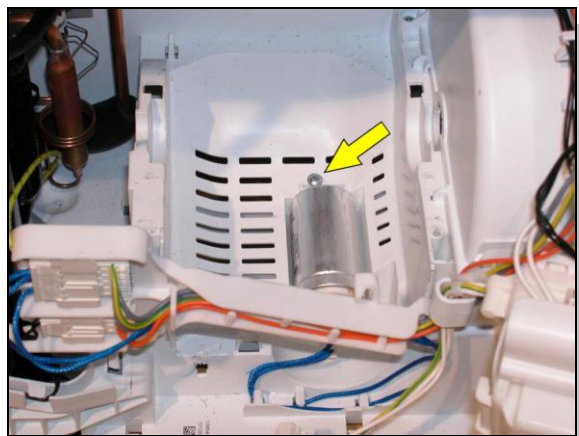

6.12 Temperature probe

- Remove the worktop.
- Remove the right side panel.

We recommend you remove the drum rotation motor to make this operation easier.

- Disconnect the probe.
- Remove the probe holding metallic clip (2).
- Pull the probe (1) upwards in order to remove it from its slot.

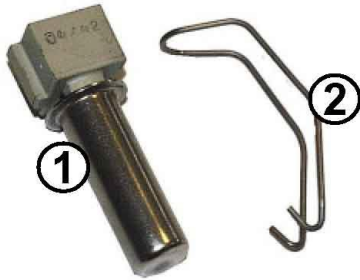

6.13 Motor protector

- To reach the thermal motor protection, loosen the screw indicated by the arrow which secures the protective cap.

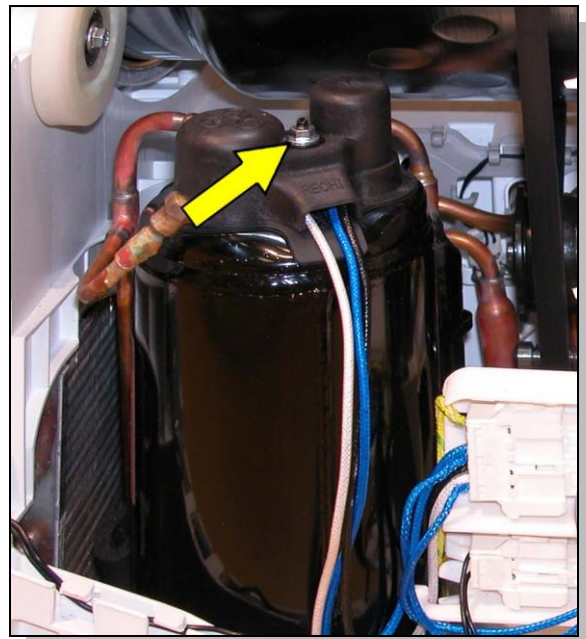

The thermal motor protection is located inside it (indicated by the arrow), kept in contact with the motor by a spring and the motor contacts.



WARNING

Before disconnecting the electrical wires, make a note of their position.

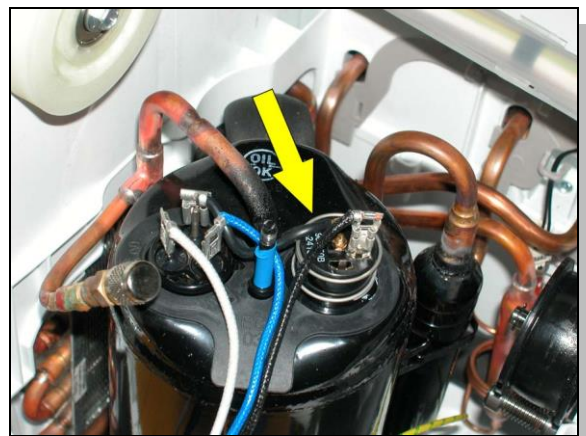

6.14 Rear panel

- Remove the worktop.
- Remove the sides.
- Using a pair of pliers open the clamp and disconnect the red pipe from the connector.
- Pull out the red pipe so it is free from the rear panel.
- Loosen the screws securing the tank fitting and remove it.

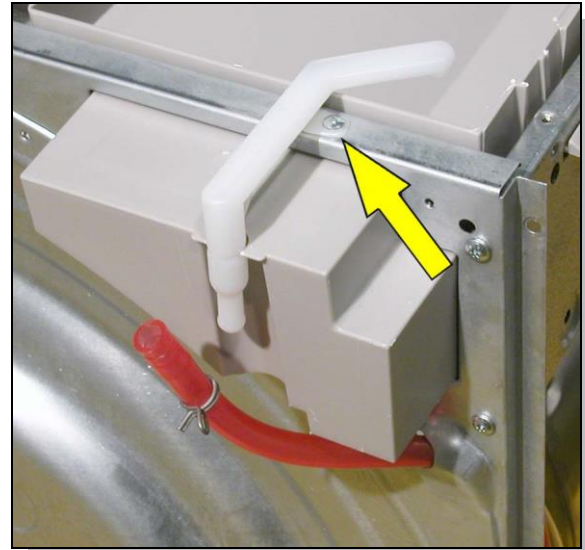

- Disconnect the power supply cable from the main board.
- Disconnect all the mass connections on the back panel.



Warning to remove the connectors slightly lower the locking lever indicated in the figure.



- Remove the rear air conduit.
- Loosen the 2 screws securing the rear panel to the appliance base.
- Loosen the 4 screws securing the rear panel to the side crossbars and the screw securing it to the central crossbar.
- Release the clip on the tank support.
- Tilt and remove the back panel.

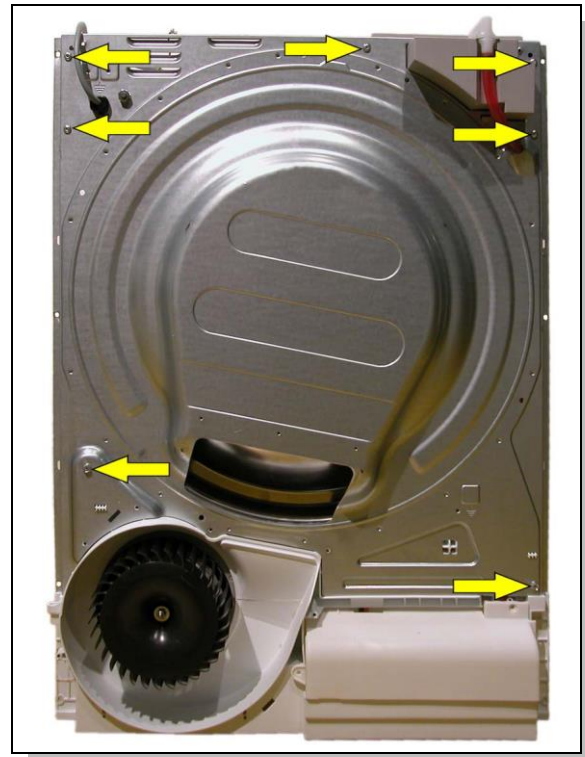

6.15 Rear air seal

- Remove the rear panel.
- Raise the air seal to remove it completely.



When repositioning the front air seal, make sure the joint is approximately positioned as shown in the figure.

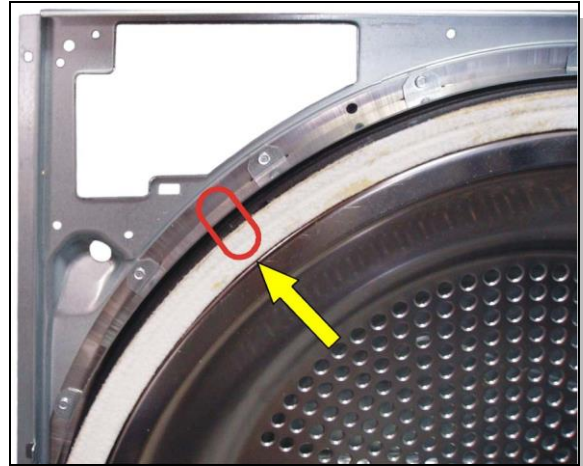

6.16 Anti-entanglement cone

The anti-entanglement cone ensures that during the drying stage the washing does not get tangled up in itself.

- Press the blocking pin to remove and rotate the cone anti-clockwise.
- Loosen the three fastening screws to also remove the base.
- Insert the cone in its slot to re-assemble it and rotate it clockwise until you hear a click that indicates the correct insertion of the blocking pin.

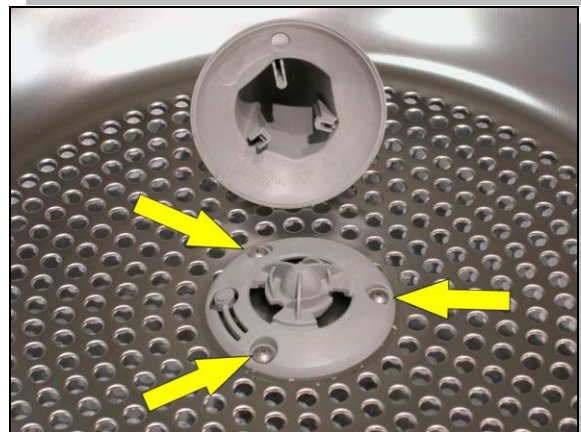
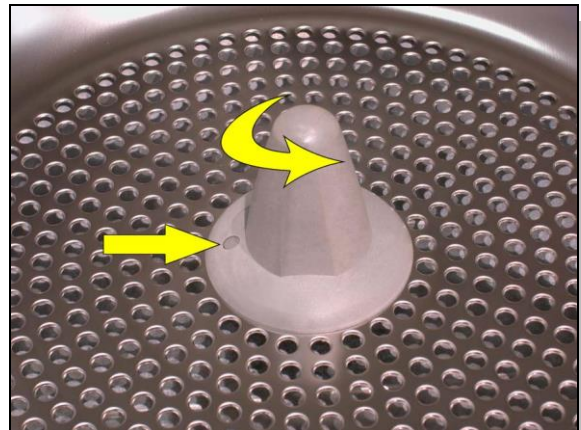

6.17 Frontal piece

- Remove the worktop.
- Remove the control panel (you do not need to disconnect it electrically).
- Loosen the 2 screws securing the appliance door to the air conduit.
- If present, remove the aesthetic cover above the door block (not shown in the figure) using a screwdriver.
- Loosen the 3 screws securing the front panel to the air conduit.

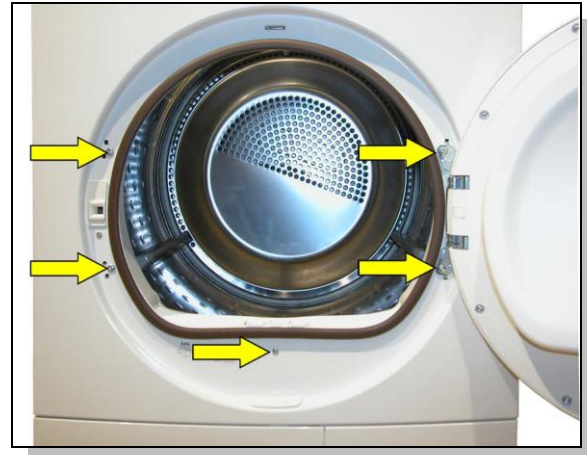

- Loosen the 2 screws on either side securing the front panel to the air conduit.
- Tilt the front panel slightly forward and lift it.

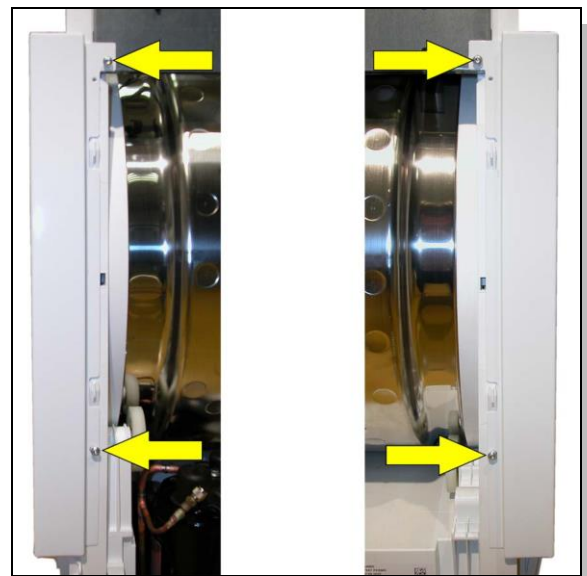

6.18 Drum light

- Remove the frontal piece.
- Disconnect the connector.
- Slightly press the two clips that hold the drum lamp and simultaneously push it inwards until it is completely removed.

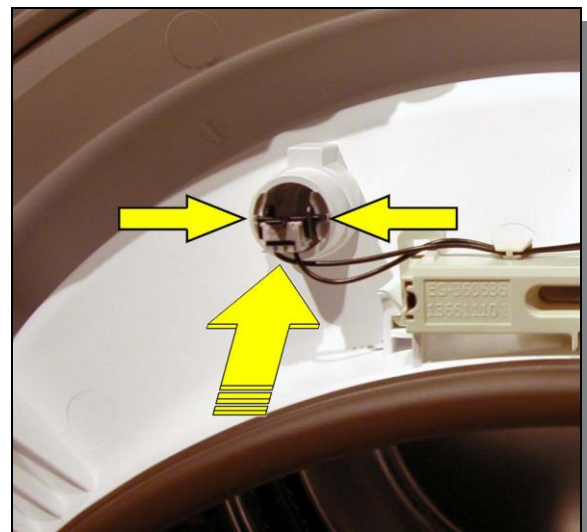

6.19 Door micro-switch

- Remove the frontal piece.
- Disconnect the connector.
- Lift the whole unit outwards.

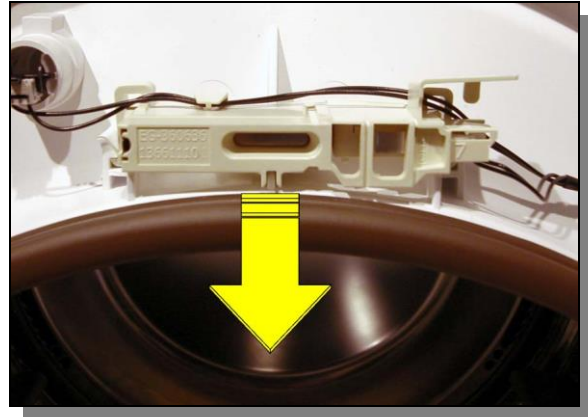

6.20 Base board

- Loosen the 2 front screws.
- Loosen the rear screw on the right side.

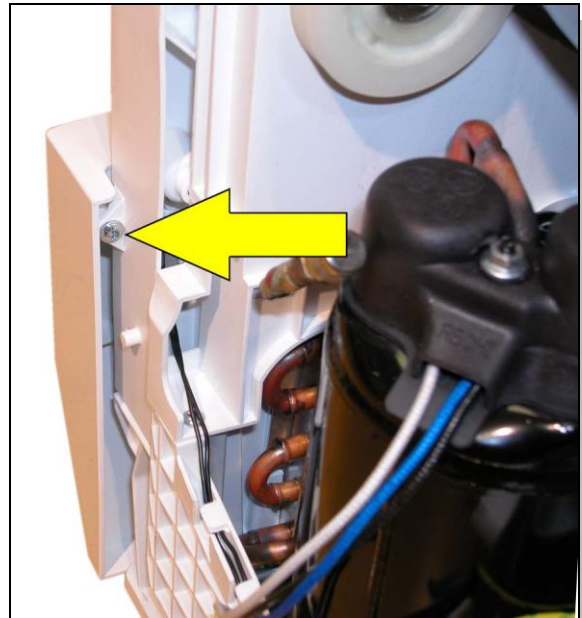

- Using a pair of pliers, unhook the holding clips on the left and right.
- When re-assembling, firstly insert the 3 lower blocking hooks.

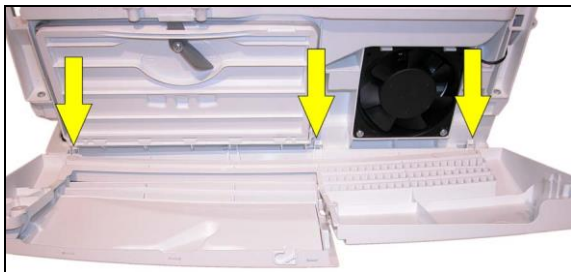

6.21 Compressor cooling fan

- Remove the worktop.
- Remove the side panels.
- Remove the support.
- Disconnect and pull out the cabling.

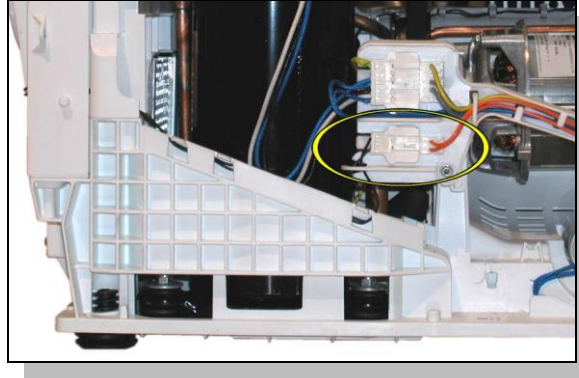

- Loosen the 2 screws that hold the fan in the lower part.
- Lift up the 2 upper holding hooks and simultaneously remove the fan.

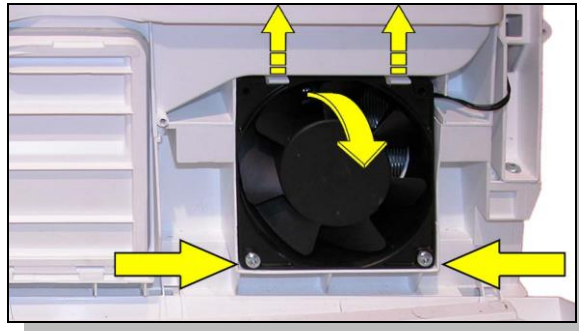

6.22 Front air conduit

- Remove the frontal piece.
- Loosen the 13 screws securing the front air conduit to the crossbars, to the tank support and to the appliance base.
- Raise the two crossbars slightly so as to remove them.
- Tilt the entire air conduit forward and lift it off.

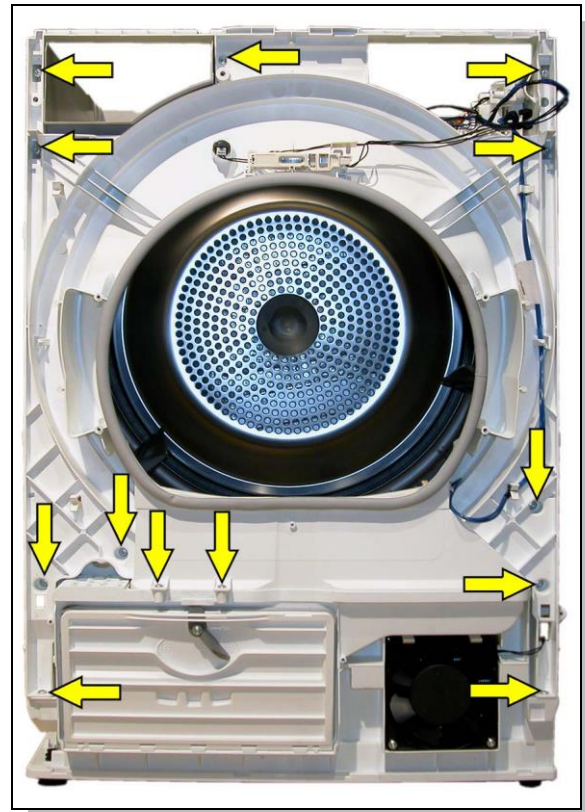

6.23 Front air seal

Once the front air conduit has been removed, the air seal can be removed.

- Raise the air seal to remove it completely.
-
- When repositioning the front air seal, make sure the joint is positioned as shown in the figure.

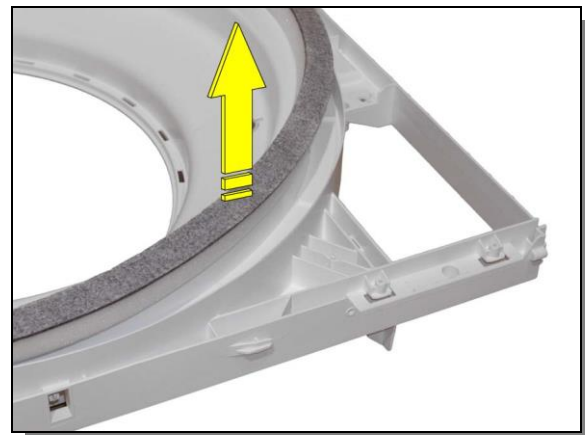

6.24 Heat exchanger compartment door

- Open the kick plate door.
- Open the heat exchanger compartment door completely.
- Turn it slightly so that the hinge pins are fully released from their seats.
- To reposition the door, position the pins on the hinges.
- Press down fully so that the hinge pins click back into their seats.



6.24.1 Heat exchanger compartment door seal

- Open the kick plate door.
- Open the heat exchanger compartment door completely. You do not need to remove it.
- Raise the seal and remove it.

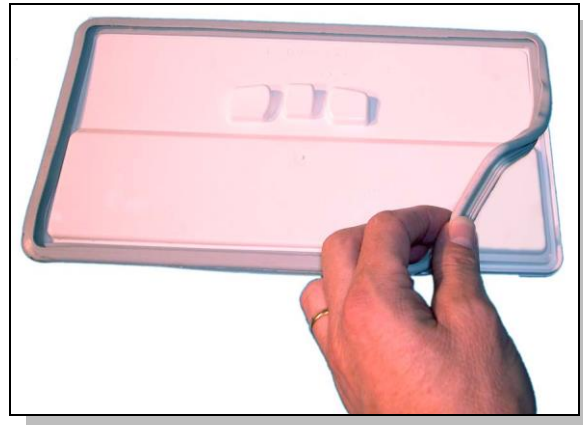

7 Alarms

Operation of the alarms is configurable according to the model. Some or all of the alarms may be displayed to the user.

When an alarm condition occurs, the drying cycle may be interrupted or paused; in some cases, for safety reasons, a forced cooling cycle is performed.

In this case, the electronic board, if possible, disconnects the power relay from the heating element and powers the drum rotation motor with cooling fan. The cycle remains active until the user switches off the appliance.

7.1 Alarm display during normal operation

On models with LCD the system displays the family of the current alarm to the user.

- First digit: letter “E”.
- Second digit: the family of the alarm.
- Third digit: the alarm number.

If we consider, for example, the alarm E53 (communication error between the motor control board and the main board), the following will be displayed:

- First digit: letter “E” (error).
- Second-third digit: the number “5 0”, i.e. the family of the alarm E53.

7.2 Reading the alarms

To read the last alarm code stored, proceed as follows:

- ⇒ Access diagnostics mode (see paragraph).
- ⇒ Turn the programme selector dial clockwise to the tenth position, the display will show the latest code stored.
- ⇒ To display any other alarms, press the START / PAUSE button.



*Try not to stop on position 8, otherwise a dummy alarm is triggered!
Alarm 32*

- First digit: letter “E”.
- Second digit: the family of the alarm.
- Third digit: the alarm number.

The configuration errors E93 are displayed through the flashing of all LEDs and it is not possible to access the diagnostics system.

7.3 Cancelling the last alarm memorised

It is good practice to cancel the alarm code from the memory:

- After reading the alarm, to check whether it is repeated during the diagnostics cycle.
 - After effecting repairs to the appliance, to check whether it is repeated during testing.
1. Start diagnostics mode.
 2. Turn the programme selector in a clockwise direction to position ten.
 3. Press the Start / Pause button and the button immediately to the left of it simultaneously.
 4. Hold the buttons down for approximately 5 seconds.
 5. After deleting, E00 will be displayed.

7.4 Notes about specific alarm codes

- **Configuration alarm E93:**

When configuration alarms are displayed (when the appliance is switched on), the appliance is inoperative and all the LEDs light. It is not possible to access diagnostics; the only operation possible is to switch off the appliance (selector knob on position "0").

- **Alarms EH1-EH2-EH3:**

In the event of problems with the power supply, the appliance remains in alarm mode until the voltage and frequency are restored to within the normal limits or the appliance is switched off. Alarm family "H" is displayed and it is not possible to access diagnostic mode nor to use the "rapid alarm display" function.

The complete alarm can be read only when the abnormal condition has terminated.

7.5 ENV06 TUMBLE DRYERS ALARMS TABLE SUMMARY

FAMILY		ALARM CODE	Full name	Action	Notes and possible causes
Ex20	CONDENSATION WATER FILLING PUMP	Ex21	Condensation water filling pump alarm	<ul style="list-style-type: none"> The cycle is suspended. If detected during configuration, the cycle start will not be permitted. 	<ul style="list-style-type: none"> Pump disconnected (wiring or connector error). Pump faulty. Water filling pump TRIAC error (short-circuit, diode mode, open circuit) (power board error).
		Ex22	Condensation water filling pump detection alarm	<ul style="list-style-type: none"> The cycle is suspended. If it is detected before the cycle starts, the cycle start will not be permitted. 	<ul style="list-style-type: none"> Pump TRIAC detection circuit error (main board error).
Ex30	CONDUCTIVITY SENSOR	Ex31	Conductivity sensor frequency too HIGH	No action.	<p>Only active during diagnostics of the HUMIDITY SENSOR SHORT-CIRCUIT.</p> <ul style="list-style-type: none"> The oscillation frequency is out of range (main board failure).
		Ex32	Conductivity sensor frequency too LOW	No action.	<p>Only active during diagnostics of the HUMIDITY SENSOR SHORT-CIRCUIT.</p> <ul style="list-style-type: none"> The drum is not short-circuited. Wiring error. The oscillation frequency is out of range (main board failure).
Ex40	DOOR	Ex45	Door closed sensing alarm	<ul style="list-style-type: none"> The cycle is suspended. If it is detected before the cycle starts, the cycle start will not be permitted. 	<p>Error in the door closed detection circuit.</p> <ul style="list-style-type: none"> Door micro-switch faulty or disconnected. Main board error.
E0x50	DRUM ROTATION MOTOR	Ex51	Motor power triac short-circuited	<ul style="list-style-type: none"> The cycle is suspended. If it is detected before the cycle starts, the cycle start will not be permitted. 	<ul style="list-style-type: none"> Motor faulty. Faulty wiring. Main circuit board faulty.
		Ex52	Motor thermal cut-out triggered	<ul style="list-style-type: none"> The cycle is suspended. If it is detected before the cycle starts, the cycle start will not be permitted. 	<ul style="list-style-type: none"> Motor faulty. Motor thermal cut-out has triggered. Faulty wiring. Main circuit board faulty.

FAMILY		ALARM CODE	Full name	Action	Notes and possible causes
		Ex53	Motor TRIAC "sensing" circuit faulty	<ul style="list-style-type: none"> The cycle is suspended. If it is detected before the cycle starts, the cycle start will not be permitted. 	<ul style="list-style-type: none"> Main circuit board faulty.
		Ex54	Motor blocked	<ul style="list-style-type: none"> The cycle is suspended. If it is detected before the cycle starts, the cycle start will not be permitted. 	<ul style="list-style-type: none"> Washing load is too large. Power supply voltage low. Motor / drive system blocked.
		Ex55	Inverter board safety alarm	<ul style="list-style-type: none"> The cycle is suspended. If it is detected before the cycle starts, the cycle start will not be permitted. 	-----
		Ex56	FCV motor plug not connected	<ul style="list-style-type: none"> Stops cycle execution 	<ul style="list-style-type: none"> Motor Wiring Motor Windings FCV Board
		E57	Inverter is drawing too much current (> 15 A)	<ul style="list-style-type: none"> The cycle is suspended. If it is detected before the cycle starts, the cycle start will not be permitted. 	<ul style="list-style-type: none"> Motor-inverter wiring faulty. Inverter board faulty. Motor faulty.
		E58	Inverter is drawing too much current (> 4.5 A)	<ul style="list-style-type: none"> The cycle is suspended. If it is detected before the cycle starts, the cycle start will not be permitted. 	<ul style="list-style-type: none"> Abnormal motor operation (overload). Motor-inverter wiring faulty. Motor faulty. Inverter board faulty.
		E59	No signal from tachometric generator for 3 seconds	<ul style="list-style-type: none"> The cycle is suspended. If it is detected before the cycle starts, the cycle start will not be permitted. 	<ul style="list-style-type: none"> Motor-inverter wiring faulty. Inverter board faulty. Motor faulty.
E0x50	DRUM ROTATION MOTOR	E5A	Overheating on cooling dissipater for inverter (> 88 °C)	<ul style="list-style-type: none"> The cycle is suspended. If it is detected before the cycle starts, the cycle start will not be permitted. 	<ul style="list-style-type: none"> Overheating caused by continuous operation or ambient conditions. Inverter board faulty. NTC open (on the inverter board).
		E5B	FCV under voltage Failure	<ul style="list-style-type: none"> Stops cycle execution 	<ul style="list-style-type: none"> Main Board - FCV power supply wiring FCV Board Failure"

FAMILY		ALARM CODE	Full name	Action	Notes and possible causes
		E5H	Input voltage is lower than 175 V	<ul style="list-style-type: none"> The cycle is suspended. If it is detected before the cycle starts, the cycle start will not be permitted. 	<ul style="list-style-type: none"> Faulty wiring. Inverter board faulty.
		E5C	Input voltage is too high - greater than 430 V	<ul style="list-style-type: none"> The cycle is suspended. If it is detected before the cycle starts, the cycle start will not be permitted. 	<ul style="list-style-type: none"> Input voltage is too high (measure the grid voltage). Inverter board faulty.
		E5d	Data transfer error between inverter and main PCB	<ul style="list-style-type: none"> The cycle is suspended. If it is detected before the cycle starts, the cycle start will not be permitted. 	<ul style="list-style-type: none"> Line interference. Faulty wiring. Main board or inverter board faulty.
		E5E	Communication error between inverter and main PCB	<ul style="list-style-type: none"> The cycle is suspended. If it is detected before the cycle starts, the cycle start will not be permitted. 	<ul style="list-style-type: none"> Faulty wiring between main board and inverter. Inverter board faulty. Main board faulty.
		E5F	Inverter PCB fails to start the motor	<ul style="list-style-type: none"> The cycle is suspended. If it is detected before the cycle starts, the cycle start will not be permitted. 	<ul style="list-style-type: none"> Faulty wiring. Inverter board faulty. Main board faulty.
		Ex60	HEATING ELEMENTS	Ex61	Compressor Hardware Failuew
		Ex62	Compressor short-circuited	<ul style="list-style-type: none"> The drying cycle is suspended. If it is detected before the cycle starts, the cycle start will not be permitted. 	<ul style="list-style-type: none"> Compressor short-circuited. Compressor current leakage. Faulty wiring. Main circuit board faulty.
		Ex63	Compressor alarm	<ul style="list-style-type: none"> The drying cycle is suspended. If it is detected before the cycle starts, the cycle start will not be permitted. 	<ul style="list-style-type: none"> Compressor disconnected (wiring or connector error). Compressor thermal cut-out has triggered. Compressor faulty. Relay error (main board faulty).
		Ex64	Compressor "sensing" circuit faulty	<ul style="list-style-type: none"> The cycle is suspended. If it is detected before the cycle starts, the cycle start will not be permitted. 	<ul style="list-style-type: none"> Error in the compressor detection circuit. Main board faulty.
		Ex65	VSC Safety Alarm	<ul style="list-style-type: none"> Stops cycle execution 	-----

FAMILY		ALARM CODE	Full name	Action	Notes and possible causes
		Ex66	VSC motor plug not connected	<ul style="list-style-type: none"> Stops cycle execution 	<ul style="list-style-type: none"> Motor Wiring Motor Windings VSC Board
		Ex67	VSC Current Trip Failure	<ul style="list-style-type: none"> Stops cycle execution 	<ul style="list-style-type: none"> VSC Board - Motor Wiring Motor Connector VSC Board
		Ex68	VSC over current Failure	<ul style="list-style-type: none"> Stops cycle execution 	<ul style="list-style-type: none"> VSC Board - Motor Wiring Motor Connector Motor mechanical blockage VSC Board
		Ex69	VSC - motor not following	<ul style="list-style-type: none"> Stops cycle execution 	<ul style="list-style-type: none"> VSC Board - Motor Wiring Motor Connector Motor mechanical blockage VSC Board
		Ex6A	VSC Board overheating	<ul style="list-style-type: none"> Stops cycle execution 	<ul style="list-style-type: none"> Motor mechanical blockage VSC Board
		Ex6B	VSC under voltage Failure	<ul style="list-style-type: none"> Stops cycle execution 	<ul style="list-style-type: none"> Main Board - VSC power supply wiring VSC Board Failure
		Ex6C	VSC over voltage Failure	<ul style="list-style-type: none"> Stops cycle execution 	<ul style="list-style-type: none"> VSC BOARD Failure
		Ex6D	VSC Failure	<ul style="list-style-type: none"> No Action 	-----
		Ex6E	VSC unknown message Failure	<ul style="list-style-type: none"> Stops cycle execution 	<ul style="list-style-type: none"> Main Board - VSC communication wiring Main Board - VSC power supply wiring Main Board or VSC Board Failure
		Ex6F	VSC Failure	<ul style="list-style-type: none"> Stops cycle execution 	<ul style="list-style-type: none"> VSC BOARD Failure

FAMILY		ALARM CODE	Full name	Action	Notes and possible causes
0x70	NTC	Ex71	Drying NTC alarm	<ul style="list-style-type: none"> The cycle is suspended. If it is detected before the cycle starts, the cycle start will not be permitted. 	<ul style="list-style-type: none"> NTC1 reading out of range. Wiring failure. NTC failure. NTC reading circuit error (main board error).
		Ex72	Heaters NTC Alarm	<ul style="list-style-type: none"> Stops cycle execution 	<ul style="list-style-type: none"> NTC2 reading out of Range Wiring Failure NTC Failure NTC reading circuit Failure (Main Board Failure)
		Ex73	Steamer NTC Alarm	<ul style="list-style-type: none"> Stops cycle execution 	<ul style="list-style-type: none"> NTC3 reading out of Range Wiring Failure NTC Failure NTC reading circuit Failure (Main Board Failure)
0x80	IU	Ex83	Incorrect selector dial position	<ul style="list-style-type: none"> No action. 	<ul style="list-style-type: none"> The code for the selector position is not recognised. Selector faulty (main board error).
		Ex86	Incorrect selector configuration	<ul style="list-style-type: none"> No action. 	<ul style="list-style-type: none"> Incorrect selector configuration (main board failure). Selector faulty (main board error).
		Ex87	Self-diagnosis of main circuit board faulty	<ul style="list-style-type: none"> No action. 	<ul style="list-style-type: none"> Main board faulty.
Ex90	CFG	Ex91	User interface board communication alarm	<ul style="list-style-type: none"> No action possible. 	<ul style="list-style-type: none"> Faulty wiring. User interface board faulty. Main board faulty.
		Ex92	Inconsistent user interface board protocol	<ul style="list-style-type: none"> No action possible. 	<ul style="list-style-type: none"> The user interface board is not compatible with the main board.
		Ex93	MCF checksum alarm	<ul style="list-style-type: none"> The machine could not work until a right configuration file is programmed. 	<ul style="list-style-type: none"> Wrong machine configuration file.
		Ex94	CCF checksum alarm	<ul style="list-style-type: none"> The machine could not work until a right configuration file is programmed. 	<ul style="list-style-type: none"> Wrong cycle configuration file.

FAMILY		ALARM CODE	Full name	Action	Notes and possible causes
		Ex97	Missing programme on CTF alarm	<ul style="list-style-type: none"> Only detected when configuration is performed. Does not allow the cycle to start. 	<ul style="list-style-type: none"> Wrong selector configuration (MCF) or missing cycle on cycle table (CCF).
		Ex98	Inconsistent inverter board protocol	<ul style="list-style-type: none"> Only detected when configuration is performed. Does not allow the cycle to start. 	<ul style="list-style-type: none"> The user interface board is not compatible with the main board. Inverter board faulty. Bad main board configuration.
		Ex9C	User interface checksum alarm	<ul style="list-style-type: none"> No action possible. 	
		Ex9E	One or more touch keys on the user interface does not work	<ul style="list-style-type: none"> No action possible. 	<ul style="list-style-type: none"> Faulty wiring. Presence of damp on the user interface board. Board faulty.
ExB0 (ExH0)	POWER SUPPLY	ExH1	Power supply frequency out of range	<ul style="list-style-type: none"> If detected in setup, it would not be possible cycle starting. If happens during cycle execution, it suspend working. It is automatically cleared when power supply return within right limits, it would be possible to start. If a cycle was temporary suspended due to this alarm it automatically restarts. 	<ul style="list-style-type: none"> Power supply problems. Wrong MCF. Main board error.
		ExH2	Power supply voltage out of range (too HIGH)		<ul style="list-style-type: none"> Power supply problems - TOO HIGH VOLTAGE. Wrong MCF. Main board error.
		ExH3	Power supply voltage out of range (too LOW)		<ul style="list-style-type: none"> Power supply problems - TOO LOW VOLTAGE. Wrong MCF. Main board error.
		ExH4	Zero Watt relay alarm	<ul style="list-style-type: none"> The tumble dryer is working properly but the zero Watt circuit is never activated. 	<ul style="list-style-type: none"> Main board faulty.
		ExHD	Current leakage alarm	<ul style="list-style-type: none"> The cycle is suspended. 	<ul style="list-style-type: none"> Current leakage of any actuator. Faulty wiring. Main board faulty.
		ExHE	Safety line alarm	<ul style="list-style-type: none"> The cycle is suspended. 	<ul style="list-style-type: none"> Main board faulty.
		ExHF	Safety line sensing alarm	<ul style="list-style-type: none"> The cycle is suspended. 	<ul style="list-style-type: none"> Main board faulty.

FAMILY		ALARM CODE	Full name	Action	Notes and possible causes
ALARMS		ExF6	Microprocessor safety reset	<ul style="list-style-type: none"> ▪ No action possible. 	<ul style="list-style-type: none"> ▪ Main board faulty.

8 Troubleshooting

8.1 The diagnostics programme cannot be accessed

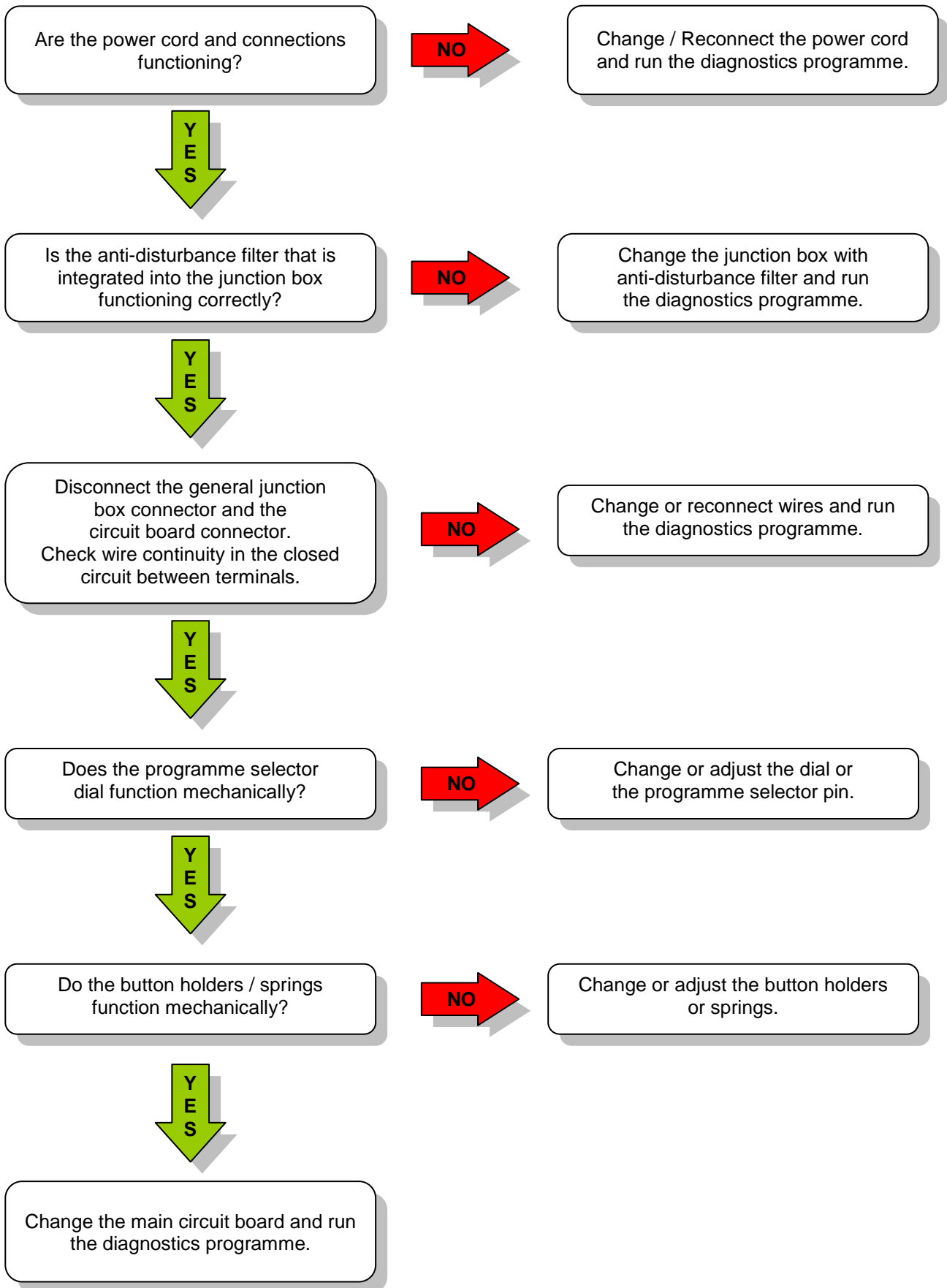

8.2 The LEDs do not light up after the buttons are pressed

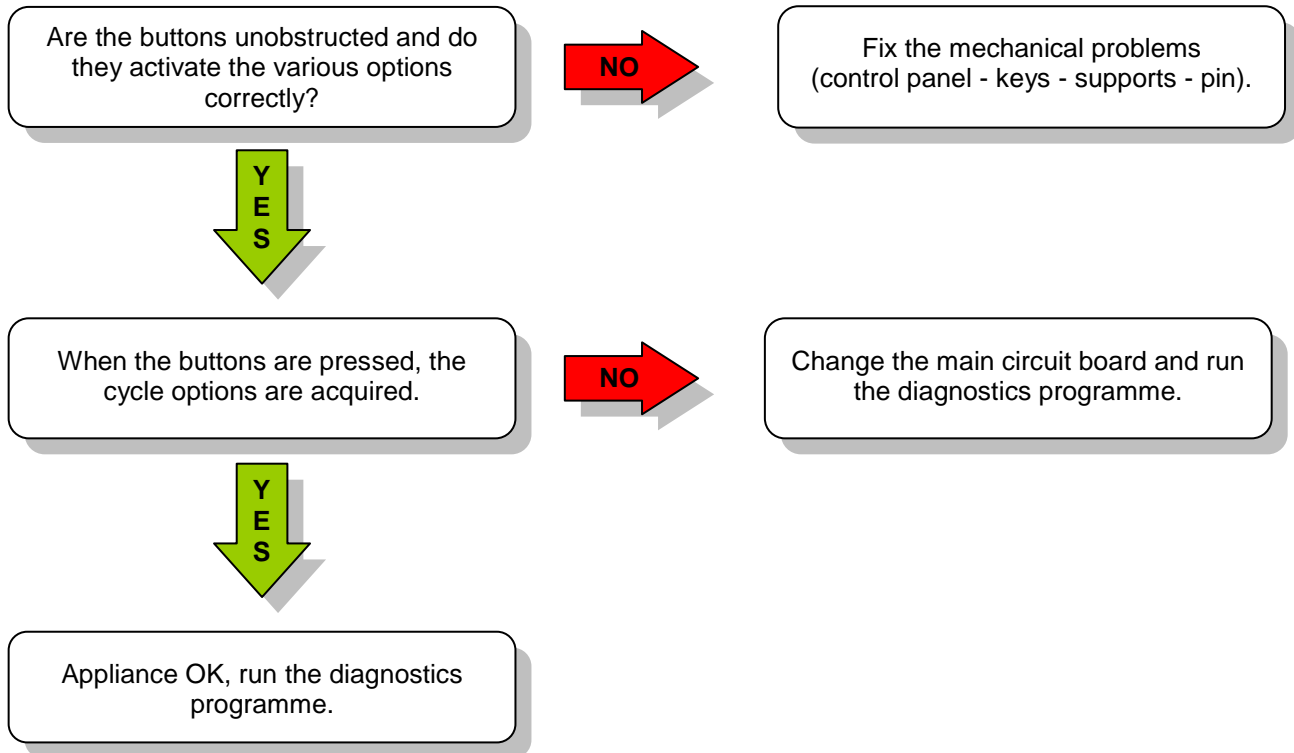

Important!

You cannot access the diagnostics system if the main circuit board has not been configured correctly: configuration errors E93 E94 are displayed by the flashing of all LEDs.

8.3 The drying cycle is long and the washing is still humid

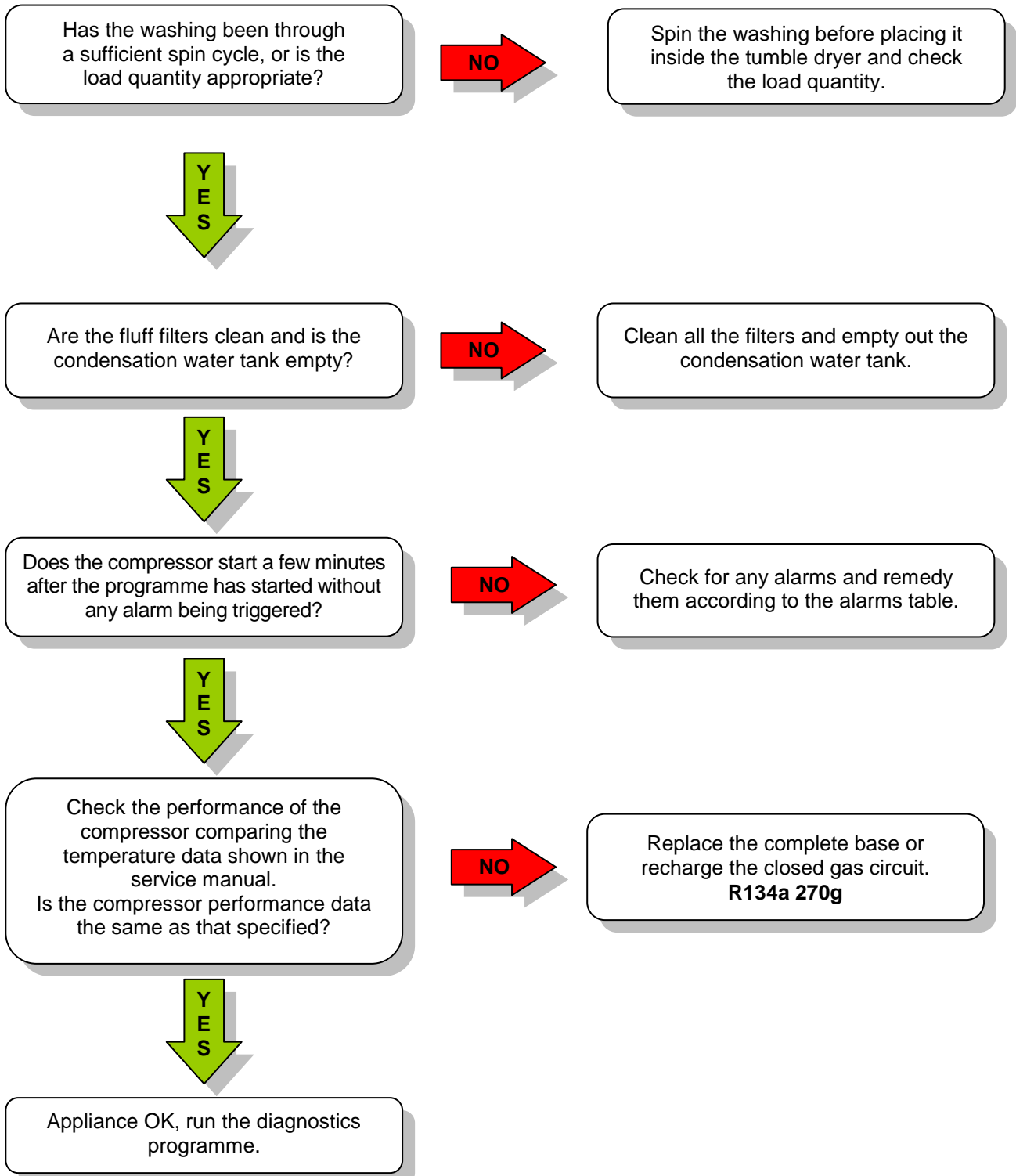

8.4 Checking the heat pump performance

To check the correct functioning of the heat pump, position the sensors in the points indicated and compare the graphs with those provided below.

In the event of significant variations, the presence of a fault is likely.

8.4.1 Models without auxiliary capacitor HP A-50%

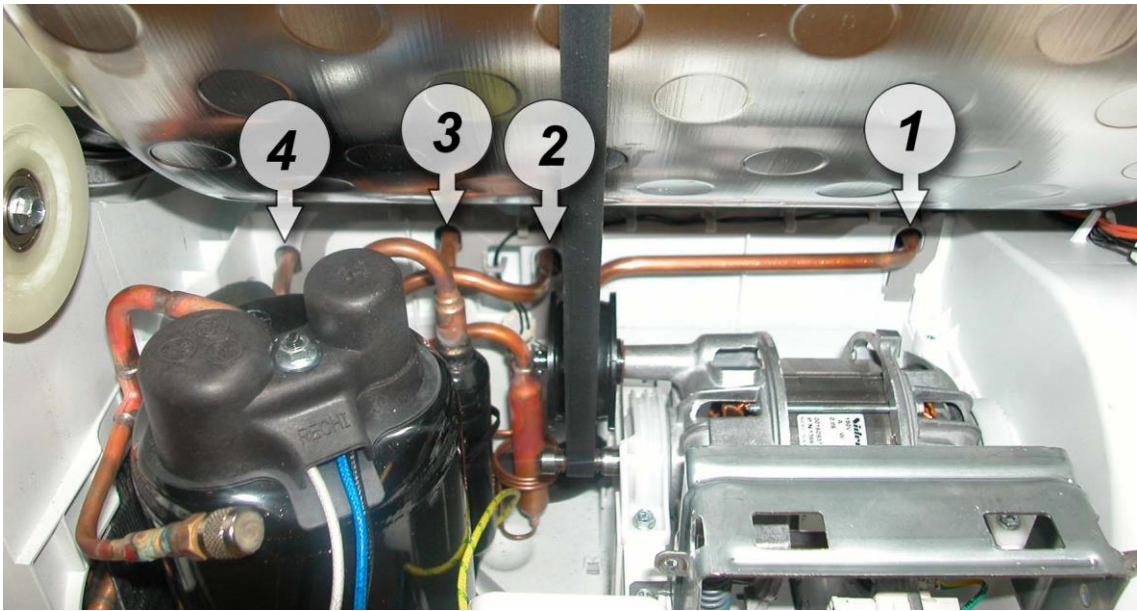

- 1 Capacitor inlet
- 2 Capacitor outlet

- 3 Evaporator inlet
- 4 Evaporator outlet

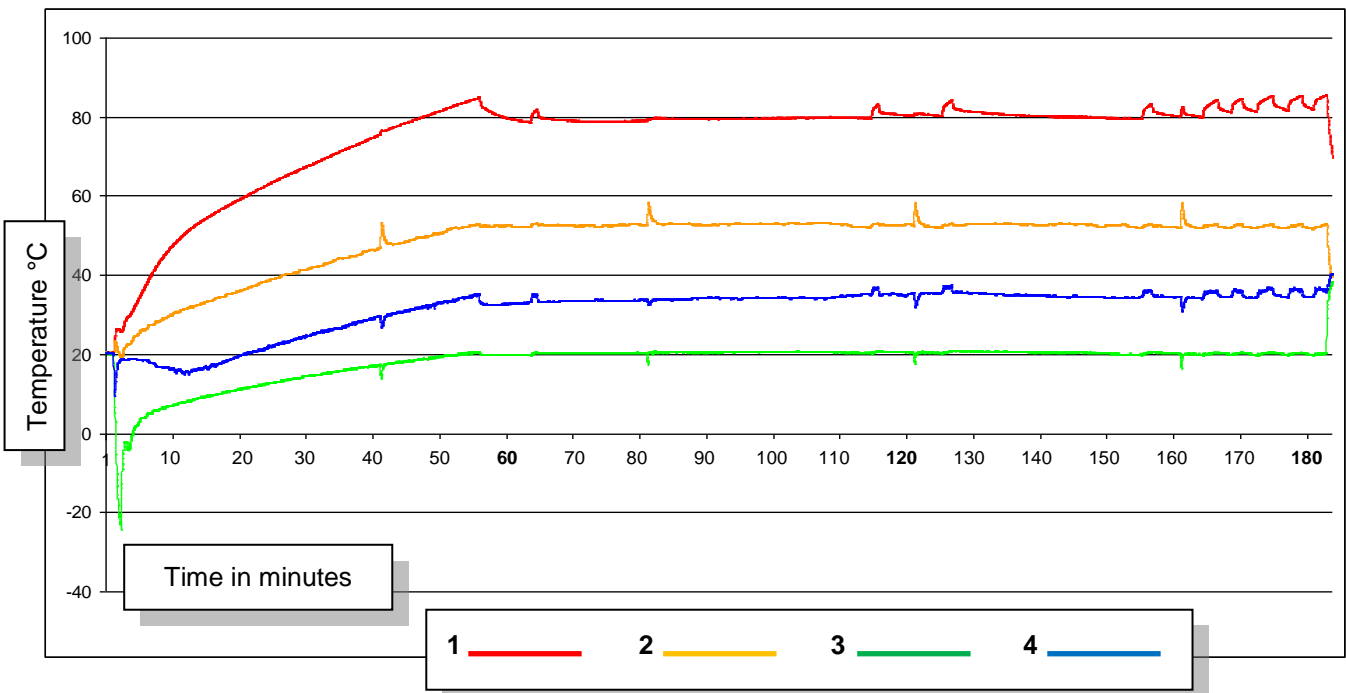

8.4.2 Models with auxiliary capacitor HP 2C

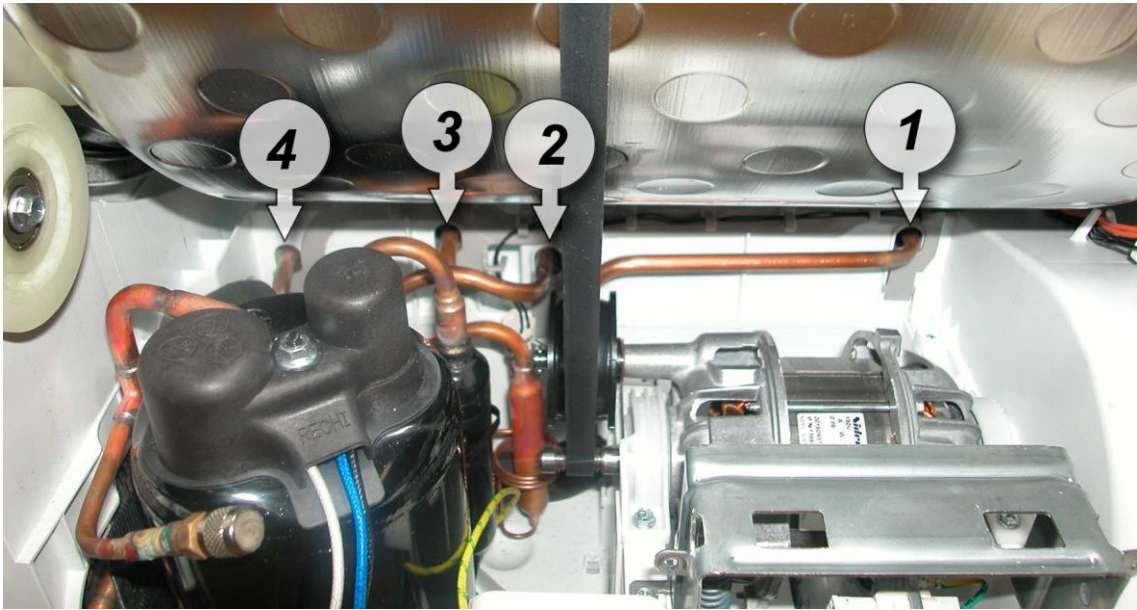

- 1** Capacitor inlet
- 2** Capacitor outlet

- 3** Evaporator inlet
- 4** Evaporator outlet

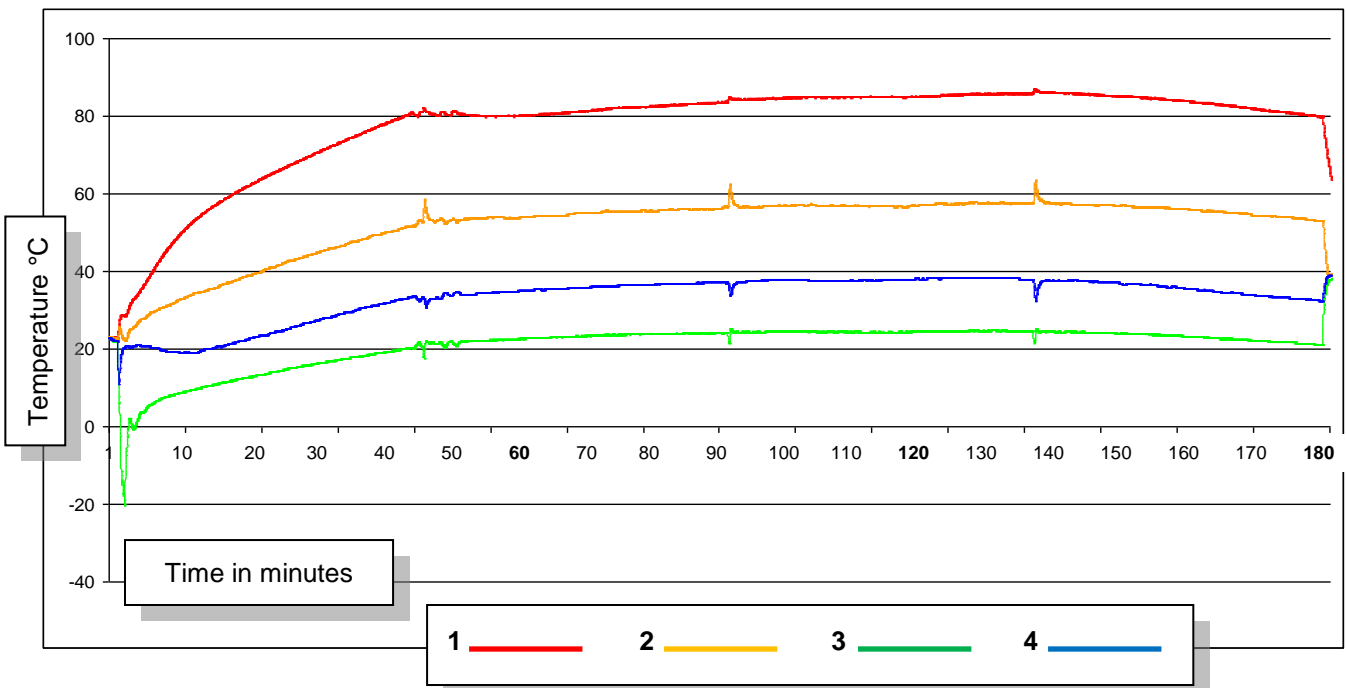

8.5 Servicing the heat pump circuit

8.5.1 Replace compressor



The circuit is evacuated with the compressor switched off.

Dispose of the R407c coolant complying with the legal provisions in your country.

- Disconnect the appliance from the power supply.
- If there is a loading and draining valve evacuate the gas by connecting the evacuation pipe directly to it.
- If there is no loading and draining valve evacuate the gas by inserting the specific pin valve (1).
- Evacuation should take 15 minutes and should only be performed on the suction side.
- During the evacuation cycle, the compressor will need to be shaken at least once to release as much gas as possible still combined with the oil.
- By doing so, as much gas and humidity as possible will be removed from the cooling circuit.



As R407c gas is not inflammable and there are no risks of explosion, it is possible to unsolder the copper pipes using a specific tool or a gas pipet.

- Unsolder the suction conduit and gas supply.
- Slacken the compressor from its slot and remove it.

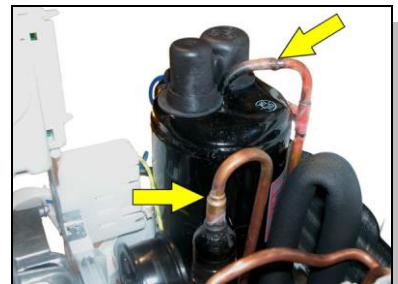

If it is not already there, connect a valve to the loading pipe (2) to carry out the gas loading stage.

This can be welded directly onto the loading pipe previously cut or, make the connections using LOCKRING connections (3).



8.5.2 Filling

The coolant can be topped up directly from the bottle using purpose-provided scales (4).

R407a coolant is supplied in disposable bottles.

During filling, the compressors must be switched off and the serviceman must wear appropriate protection devices.

R407c 570g models without auxiliary capacitor.

R407c 650g models with auxiliary capacitor.



9 Door reversibility

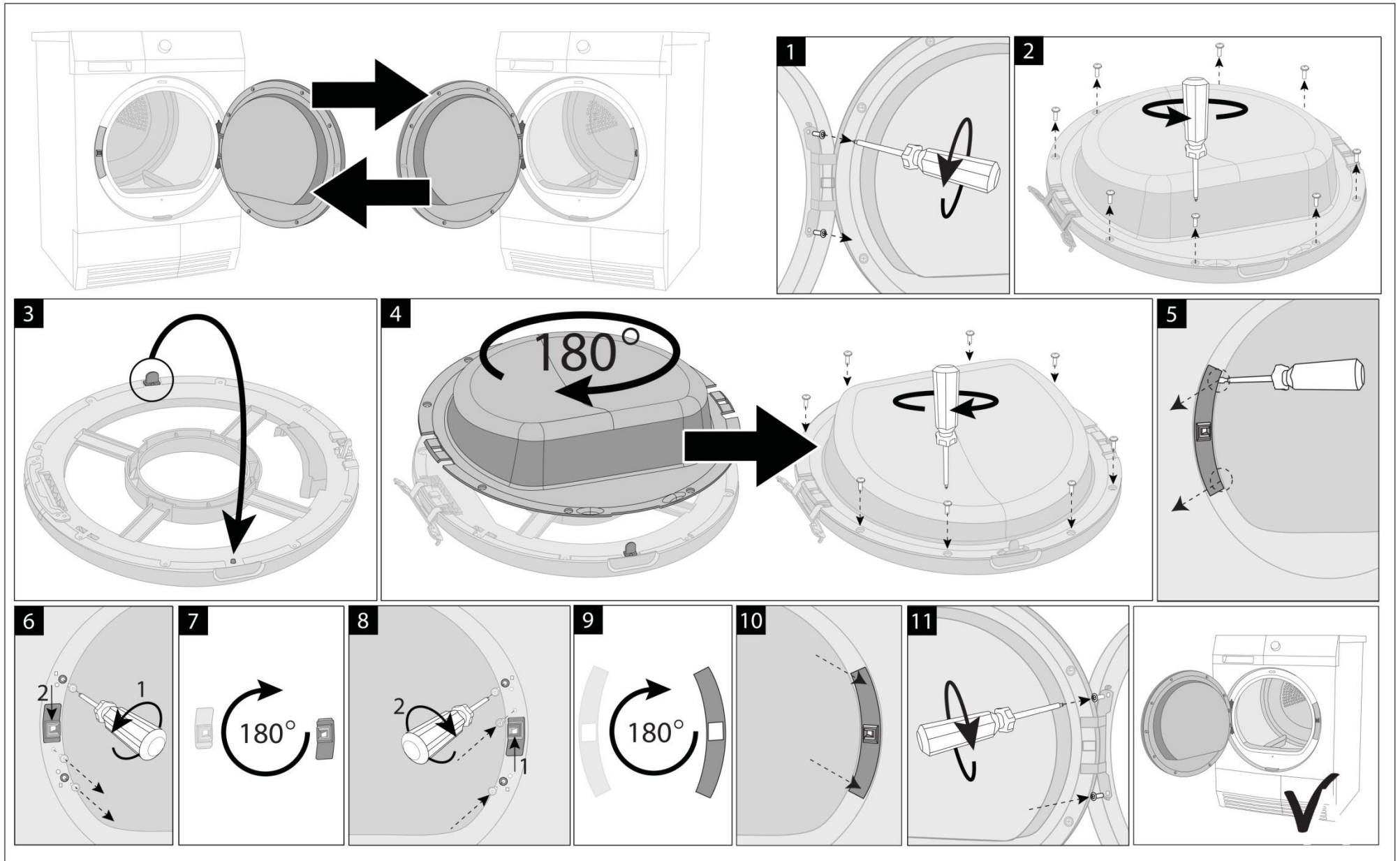

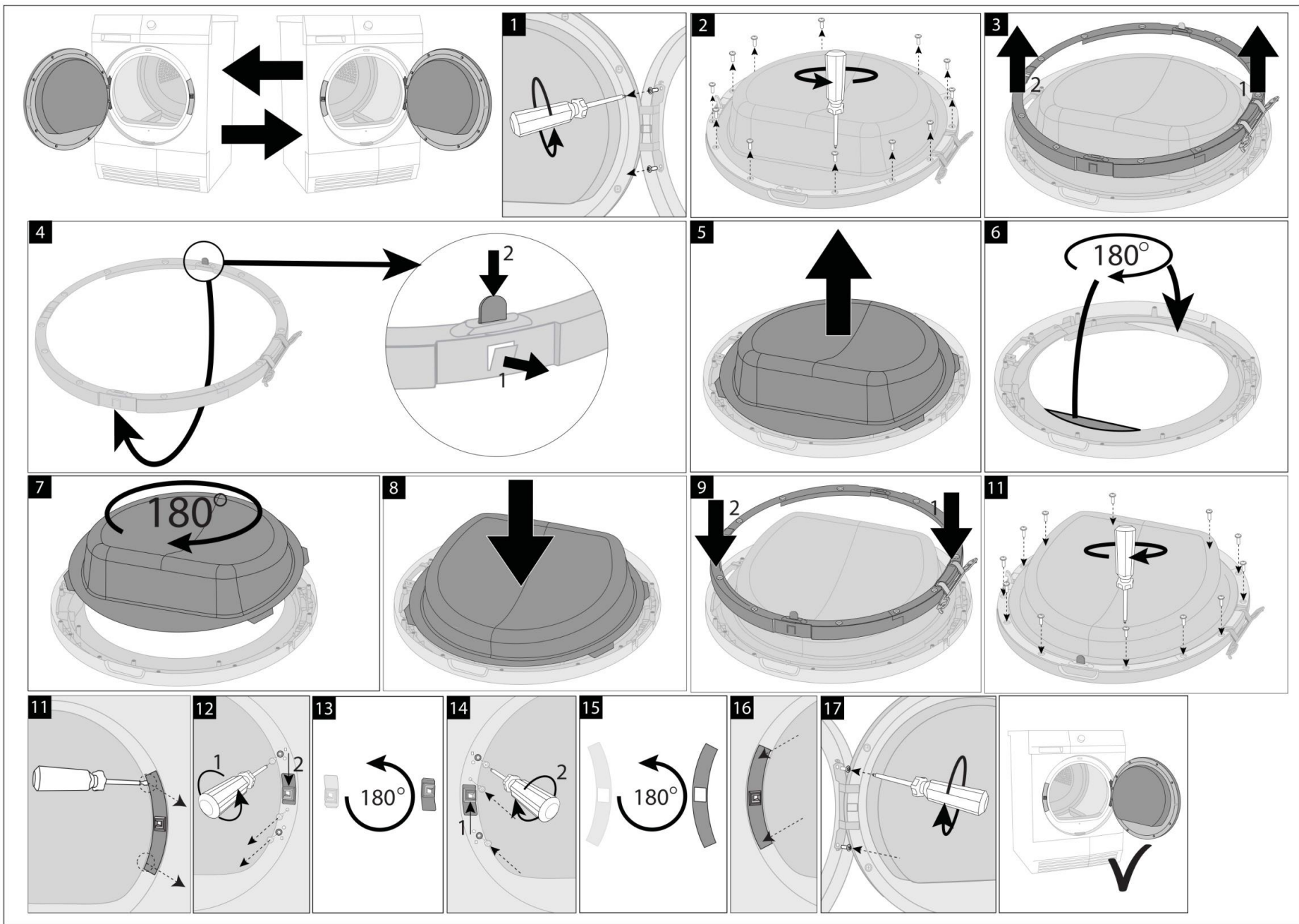

10 Revisions

Revision	Date	Description	Written by	Approved by - on
00	07/2011	Document creation	A.D.L.	
01	08/2015	Alarms table update	MP	